

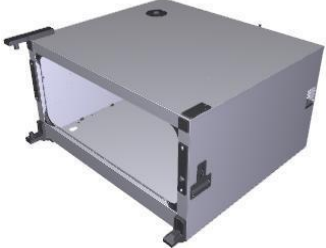



| Assembly code | Assembly description | Assembly image |
|----------------|----------------------|---|
| ASM3403A/0.D01 | Cooking chamber |  |
| ASM3415A/0.D01 | External cover |  |
| ASM3429B/0.D00 | Door |  |
| ASM8226A/0.D00 | Electrical system |  |



ASM3403A/0.D01 - Cooking chamber - FRONT

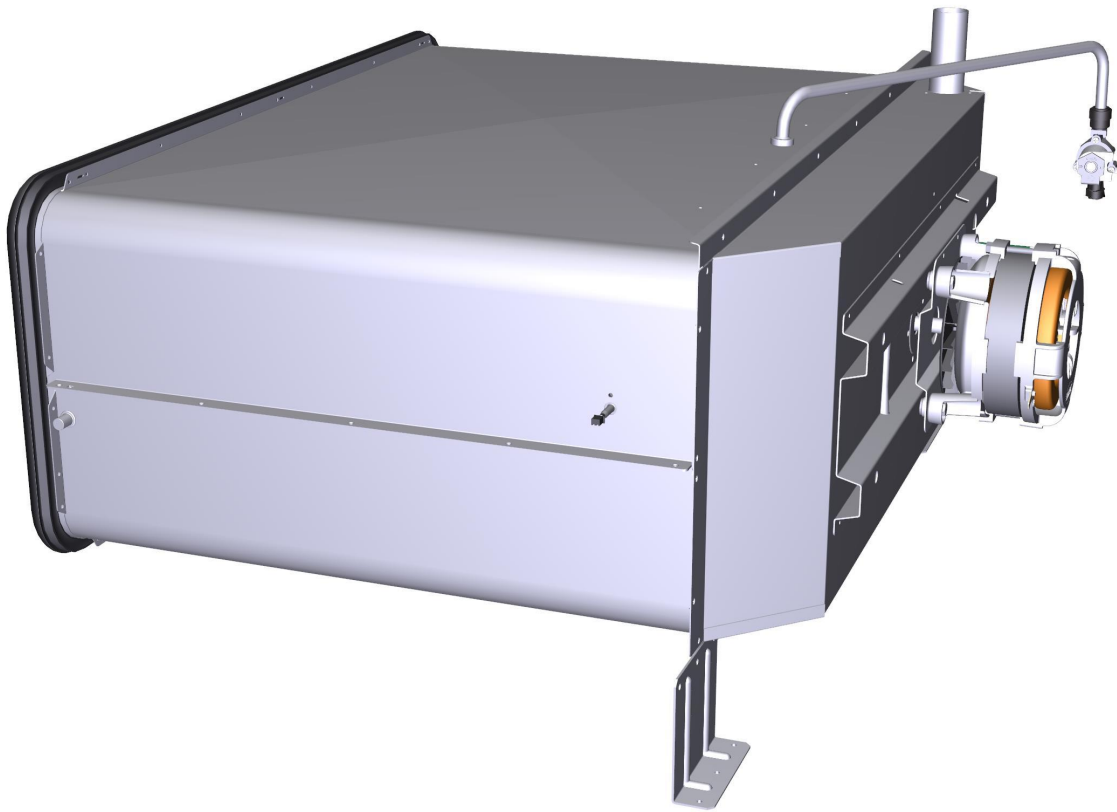





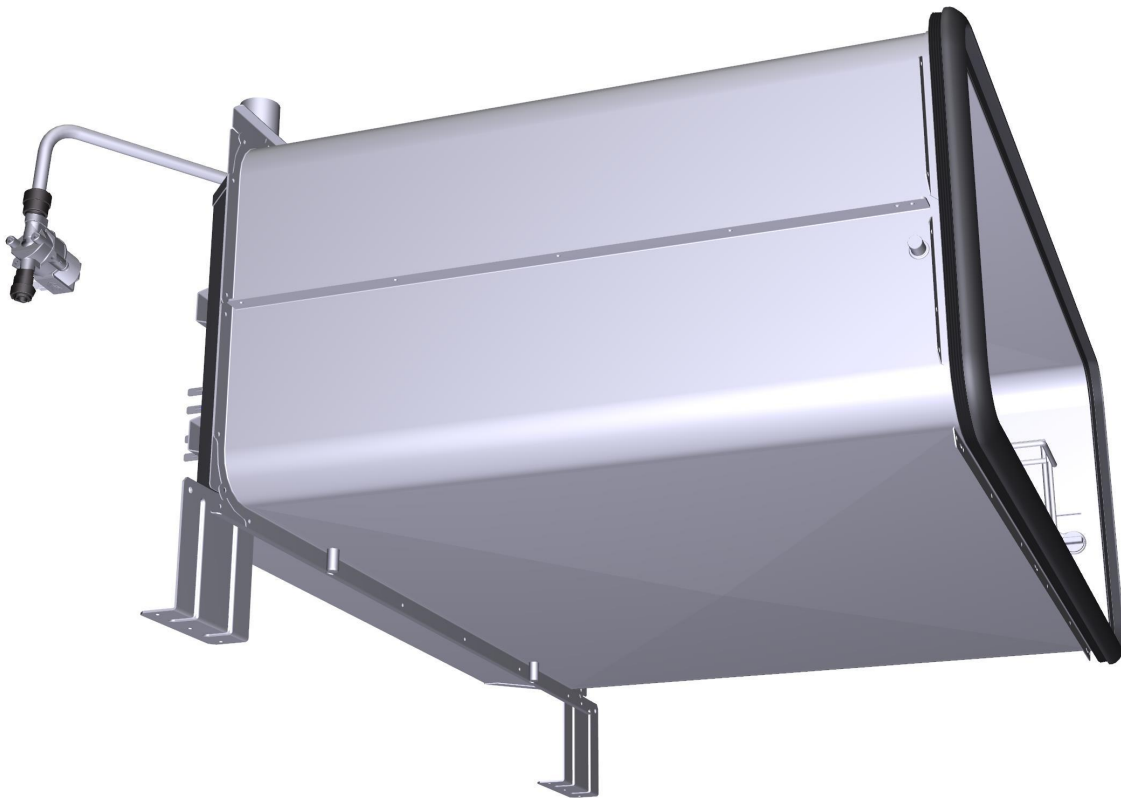



ASM3403A/0.D01 - Cooking chamber - REAR

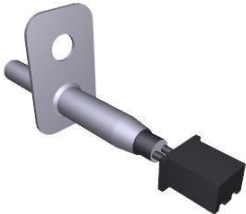









| COMPONENT | | | SPARE PART | | | | | | | | | | | | | | | | | | | | | | | | | | | | | | | | | | | | | | | | | | |
|-----------|-------------------------------------|---|------------|-----------------------------------|--|------|-------------|-----|-----|----------|-----------------------|-------|----|----------|-----------------------------|-------|----|----------|--------------------------------|-------|----|----------|-------------------------------------|-------|----|----------|--------------------------------|-------|----|----------|--------------------------------|-------|----|----------|--------------------------------|-------|----|----------|--------------------------------|-------|----|----------|--------------------|-------|----|
| Code | Description | Image | Code | Description | Kit components | | | | | | | | | | | | | | | | | | | | | | | | | | | | | | | | | | | | | | | | |
| 0G1653A | ELENA SHOP PRO FAN GUARD |  | 0G1653A1 | ELENA SHOP PRO FAN GUARD | | | | | | | | | | | | | | | | | | | | | | | | | | | | | | | | | | | | | | | | | |
| 0H7875A | SHOP.PRO MUFFLE SUPPORT BRACKET |  | 0H7875A1 | SHOP.PRO MUFFLE SUPPORT BRACKET | | | | | | | | | | | | | | | | | | | | | | | | | | | | | | | | | | | | | | | | | |
| TR1105A | L1000 PT100 TEMPERATURE PROBE |  | KTR1105A | PT100 L1000 TEMPERATURE PROBE KIT | <table border="1"> <thead> <tr> <th>Code</th> <th>Description</th> <th>Qty</th> <th>UOM</th> </tr> </thead> <tbody> <tr> <td>0H4302A0</td> <td>PROBES SILICON HOLDER</td> <td>1.000</td> <td>PC</td> </tr> <tr> <td>GN1120A1</td> <td>NTC TEMPERATUR E PROBE SEAL</td> <td>1.000</td> <td>PC</td> </tr> <tr> <td>GN1285A0</td> <td>NTC TEMPERATUR E PROBE SEALING</td> <td>1.000</td> <td>PC</td> </tr> <tr> <td>SL1045A0</td> <td>S57 BLACK SILICONE - 80ml CARTRIDGE</td> <td>1.000</td> <td>PC</td> </tr> <tr> <td>TR1105A4</td> <td>L1000 PT100 TEMPERATUR E PROBE</td> <td>1.000</td> <td>PC</td> </tr> <tr> <td>VI1220A1</td> <td>4,2x12 TCB SELF-TAPPIN G SCREW</td> <td>2.000</td> <td>PC</td> </tr> <tr> <td>VM1464A1</td> <td>CT BT TEMPERATUR E PROBE COVER</td> <td>1.000</td> <td>PC</td> </tr> <tr> <td>VM1465A1</td> <td>CT BT TEMPERATUR E PROBE COVER</td> <td>1.000</td> <td>PC</td> </tr> <tr> <td>VM2052A0</td> <td>LM CORE PROBE COVE</td> <td>1.000</td> <td>PC</td> </tr> </tbody> </table> | Code | Description | Qty | UOM | 0H4302A0 | PROBES SILICON HOLDER | 1.000 | PC | GN1120A1 | NTC TEMPERATUR E PROBE SEAL | 1.000 | PC | GN1285A0 | NTC TEMPERATUR E PROBE SEALING | 1.000 | PC | SL1045A0 | S57 BLACK SILICONE - 80ml CARTRIDGE | 1.000 | PC | TR1105A4 | L1000 PT100 TEMPERATUR E PROBE | 1.000 | PC | VI1220A1 | 4,2x12 TCB SELF-TAPPIN G SCREW | 2.000 | PC | VM1464A1 | CT BT TEMPERATUR E PROBE COVER | 1.000 | PC | VM1465A1 | CT BT TEMPERATUR E PROBE COVER | 1.000 | PC | VM2052A0 | LM CORE PROBE COVE | 1.000 | PC |
| Code | Description | Qty | UOM | | | | | | | | | | | | | | | | | | | | | | | | | | | | | | | | | | | | | | | | | | |
| 0H4302A0 | PROBES SILICON HOLDER | 1.000 | PC | | | | | | | | | | | | | | | | | | | | | | | | | | | | | | | | | | | | | | | | | | |
| GN1120A1 | NTC TEMPERATUR E PROBE SEAL | 1.000 | PC | | | | | | | | | | | | | | | | | | | | | | | | | | | | | | | | | | | | | | | | | | |
| GN1285A0 | NTC TEMPERATUR E PROBE SEALING | 1.000 | PC | | | | | | | | | | | | | | | | | | | | | | | | | | | | | | | | | | | | | | | | | | |
| SL1045A0 | S57 BLACK SILICONE - 80ml CARTRIDGE | 1.000 | PC | | | | | | | | | | | | | | | | | | | | | | | | | | | | | | | | | | | | | | | | | | |
| TR1105A4 | L1000 PT100 TEMPERATUR E PROBE | 1.000 | PC | | | | | | | | | | | | | | | | | | | | | | | | | | | | | | | | | | | | | | | | | | |
| VI1220A1 | 4,2x12 TCB SELF-TAPPIN G SCREW | 2.000 | PC | | | | | | | | | | | | | | | | | | | | | | | | | | | | | | | | | | | | | | | | | | |
| VM1464A1 | CT BT TEMPERATUR E PROBE COVER | 1.000 | PC | | | | | | | | | | | | | | | | | | | | | | | | | | | | | | | | | | | | | | | | | | |
| VM1465A1 | CT BT TEMPERATUR E PROBE COVER | 1.000 | PC | | | | | | | | | | | | | | | | | | | | | | | | | | | | | | | | | | | | | | | | | | |
| VM2052A0 | LM CORE PROBE COVE | 1.000 | PC | | | | | | | | | | | | | | | | | | | | | | | | | | | | | | | | | | | | | | | | | | |





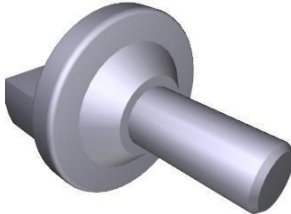

| COMPONENT | | | SPARE PART | | | | | | | | | | | | | | | | | | | | | | |
|-----------|--|---|------------|---------------------------------------|---|------|-------------|-----|-----|----------|----------------------------|-------|----|----------|----------------------------|-------|----|----------|---------------------------------|-------|----|----------|--|-------|----|
| Code | Description | Image | Code | Description | Kit components | | | | | | | | | | | | | | | | | | | | |
| EL1251A | 1-WAY WATER SOLENOID VALVE |  | KEL1251A | JG D8-D10 1 WAY SOLENOID VALVE KI | <table border="1"> <thead> <tr> <th>Code</th> <th>Description</th> <th>Qty</th> <th>UOM</th> </tr> </thead> <tbody> <tr> <td>EL1251A0</td> <td>1-WAY WATER SOLENOID VALVE</td> <td>1.000</td> <td>PC</td> </tr> </tbody> </table> | Code | Description | Qty | UOM | EL1251A0 | 1-WAY WATER SOLENOID VALVE | 1.000 | PC | | | | | | | | | | | | |
| Code | Description | Qty | UOM | | | | | | | | | | | | | | | | | | | | | | |
| EL1251A0 | 1-WAY WATER SOLENOID VALVE | 1.000 | PC | | | | | | | | | | | | | | | | | | | | | | |
| 0H3020A | MOTOR SHAFT SEALING DISC |  | 0H3020A1 | MOTOR SHAFT SEALING DISC | | | | | | | | | | | | | | | | | | | | | |
| 0H7170A | MM MOTOR GLASS WOOL PLATE |  | 0H7170A0 | MM MOTOR GLASS WOOL PLATE | | | | | | | | | | | | | | | | | | | | | |
| GN1547A | SHAFT GASKET D11.8 |  | KG1547A | D11.6 MOTOR SHAFT GASKET 3PCS KIT | <table border="1"> <thead> <tr> <th>Code</th> <th>Description</th> <th>Qty</th> <th>UOM</th> </tr> </thead> <tbody> <tr> <td>GN1547A1</td> <td>SHAFT GASKET D11.8</td> <td>3.000</td> <td>PC</td> </tr> </tbody> </table> | Code | Description | Qty | UOM | GN1547A1 | SHAFT GASKET D11.8 | 3.000 | PC | | | | | | | | | | | | |
| Code | Description | Qty | UOM | | | | | | | | | | | | | | | | | | | | | | |
| GN1547A1 | SHAFT GASKET D11.8 | 3.000 | PC | | | | | | | | | | | | | | | | | | | | | | |
| MT1012A | 330W 230V MOTOR |  | KVN1130A | LUX ≤08.2017/L.MISS/S.5/ 5E MOTOR KIT | <table border="1"> <thead> <tr> <th>Code</th> <th>Description</th> <th>Qty</th> <th>UOM</th> </tr> </thead> <tbody> <tr> <td>0H8118A0</td> <td>XEVL MOTOR SHAFT DISC</td> <td>1.000</td> <td>PC</td> </tr> <tr> <td>GN1140A3</td> <td>MOLDED MOTOR HOLDER GASKET</td> <td>1.000</td> <td>PC</td> </tr> <tr> <td>VI1034A0</td> <td>STAINLESS STEEL WASHER 8.4x16x1</td> <td>1.000</td> <td>PC</td> </tr> <tr> <td>VI1256A0</td> <td>M8 DIN 980M ST. STEEL SELF LOCKING NUT</td> <td>1.000</td> <td>PC</td> </tr> </tbody> </table> | Code | Description | Qty | UOM | 0H8118A0 | XEVL MOTOR SHAFT DISC | 1.000 | PC | GN1140A3 | MOLDED MOTOR HOLDER GASKET | 1.000 | PC | VI1034A0 | STAINLESS STEEL WASHER 8.4x16x1 | 1.000 | PC | VI1256A0 | M8 DIN 980M ST. STEEL SELF LOCKING NUT | 1.000 | PC |
| Code | Description | Qty | UOM | | | | | | | | | | | | | | | | | | | | | | |
| 0H8118A0 | XEVL MOTOR SHAFT DISC | 1.000 | PC | | | | | | | | | | | | | | | | | | | | | | |
| GN1140A3 | MOLDED MOTOR HOLDER GASKET | 1.000 | PC | | | | | | | | | | | | | | | | | | | | | | |
| VI1034A0 | STAINLESS STEEL WASHER 8.4x16x1 | 1.000 | PC | | | | | | | | | | | | | | | | | | | | | | |
| VI1256A0 | M8 DIN 980M ST. STEEL SELF LOCKING NUT | 1.000 | PC | | | | | | | | | | | | | | | | | | | | | | |

| COMPONENT | | | SPARE PART | | | | | | | | | | | | | | | | | | | | | | | | | | | | | | | |
|-----------|---|--|------------|---|--|------|-------------|---|-------|----------|-----------------------------------|-----------------------------------|-------|----------|--|-------------------------------------|-------|----------|-------------------------------------|--------------------|-------|----|----------|------------------------|-------|----|----------|--|-------|----|----------|----------------------------|-------|----|
| Code | Description | Image | Code | Description | Kit components | | | | | | | | | | | | | | | | | | | | | | | | | | | | | |
| MT1012A | 330W 230V MOTOR |  | KVN1130A | LUX ≤08.2017/L.MISS/S.5/ 5E MOTOR KIT | <table border="1"> <thead> <tr> <th>Code</th> <th>Description</th> <th>Qty</th> <th>UOM</th> </tr> </thead> <tbody> <tr> <td>VM2196A0</td> <td>MOTOR NUT FASTENING BUSHING</td> <td>1.000</td> <td>PC</td> </tr> <tr> <td>VN1130A1</td> <td>330W 230V 50/60HZ MOTO</td> <td>1.000</td> <td>PC</td> </tr> </tbody> </table> | Code | Description | Qty | UOM | VM2196A0 | MOTOR NUT FASTENING BUSHING | 1.000 | PC | VN1130A1 | 330W 230V 50/60HZ MOTO | 1.000 | PC | | | | | | | | | | | | | | | | | |
| | | | Code | Description | Qty | UOM | | | | | | | | | | | | | | | | | | | | | | | | | | | | |
| VM2196A0 | MOTOR NUT FASTENING BUSHING | 1.000 | PC | | | | | | | | | | | | | | | | | | | | | | | | | | | | | | | |
| VN1130A1 | 330W 230V 50/60HZ MOTO | 1.000 | PC | | | | | | | | | | | | | | | | | | | | | | | | | | | | | | | |
| KMT1012A | LUX >08.2017 / MIND.MAPS 330W MOTOR KIT | <table border="1"> <thead> <tr> <th>Code</th> <th>Description</th> <th>Qty</th> <th>UOM</th> </tr> </thead> <tbody> <tr> <td>0H2842A0</td> <td>MT1012 CENTERING JI</td> <td>1.000</td> <td>PC</td> </tr> <tr> <td>0H8118A0</td> <td>XEVL MOTOR SHAFT DISC</td> <td>1.000</td> <td>PC</td> </tr> <tr> <td>GN1140A3</td> <td>MOLDED MOTOR HOLDER GASKET</td> <td>1.000</td> <td>PC</td> </tr> <tr> <td>MT1012A0</td> <td>330W 230V MOTOR</td> <td>1.000</td> <td>PC</td> </tr> <tr> <td>VI1077A1</td> <td>SCREW M6x12 TE INOX</td> <td>1.000</td> <td>PC</td> </tr> <tr> <td>VI1521A0</td> <td>STAINLESS STEEL WASHER D=6 6592</td> <td>1.000</td> <td>PC</td> </tr> <tr> <td>VI1966A1</td> <td>M4x14 FLATHEAD SCREW</td> <td>1.000</td> <td>PC</td> </tr> </tbody> </table> | Code | Description | Qty | UOM | 0H2842A0 | MT1012 CENTERING JI | 1.000 | PC | 0H8118A0 | XEVL MOTOR SHAFT DISC | 1.000 | PC | GN1140A3 | MOLDED MOTOR HOLDER GASKET | 1.000 | PC | MT1012A0 | 330W 230V MOTOR | 1.000 | PC | VI1077A1 | SCREW M6x12 TE INOX | 1.000 | PC | VI1521A0 | STAINLESS STEEL WASHER D=6 6592 | 1.000 | PC | VI1966A1 | M4x14 FLATHEAD SCREW | 1.000 | PC |
| Code | Description | Qty | UOM | | | | | | | | | | | | | | | | | | | | | | | | | | | | | | | |
| 0H2842A0 | MT1012 CENTERING JI | 1.000 | PC | | | | | | | | | | | | | | | | | | | | | | | | | | | | | | | |
| 0H8118A0 | XEVL MOTOR SHAFT DISC | 1.000 | PC | | | | | | | | | | | | | | | | | | | | | | | | | | | | | | | |
| GN1140A3 | MOLDED MOTOR HOLDER GASKET | 1.000 | PC | | | | | | | | | | | | | | | | | | | | | | | | | | | | | | | |
| MT1012A0 | 330W 230V MOTOR | 1.000 | PC | | | | | | | | | | | | | | | | | | | | | | | | | | | | | | | |
| VI1077A1 | SCREW M6x12 TE INOX | 1.000 | PC | | | | | | | | | | | | | | | | | | | | | | | | | | | | | | | |
| VI1521A0 | STAINLESS STEEL WASHER D=6 6592 | 1.000 | PC | | | | | | | | | | | | | | | | | | | | | | | | | | | | | | | |
| VI1966A1 | M4x14 FLATHEAD SCREW | 1.000 | PC | | | | | | | | | | | | | | | | | | | | | | | | | | | | | | | |
| VN1181A | M6 NUT 39 BLADES H81 D196 FAN |  | KVN1181A | D196 H81 39 BLADES FAN+SCREW M6 KIT | <table border="1"> <thead> <tr> <th>Code</th> <th>Description</th> <th>Qty</th> <th>UOM</th> </tr> </thead> <tbody> <tr> <td>VI1077A1</td> <td>SCREW M6x12 TE INOX</td> <td>1.000</td> <td>PC</td> </tr> <tr> <td>VI1521A0</td> <td>STAINLESS STEEL WASHER D=6 6592</td> <td>1.000</td> <td>PC</td> </tr> <tr> <td>VN1181A0</td> <td>M6 NUT 39 BLADES H81 D196 FAN</td> <td>1.000</td> <td>PC</td> </tr> </tbody> </table> | Code | Description | Qty | UOM | VI1077A1 | SCREW M6x12 TE INOX | 1.000 | PC | VI1521A0 | STAINLESS STEEL WASHER D=6 6592 | 1.000 | PC | VN1181A0 | M6 NUT 39 BLADES H81 D196 FAN | 1.000 | PC | | | | | | | | | | | | | |
| | | | Code | Description | Qty | UOM | | | | | | | | | | | | | | | | | | | | | | | | | | | | |
| VI1077A1 | SCREW M6x12 TE INOX | 1.000 | PC | | | | | | | | | | | | | | | | | | | | | | | | | | | | | | | |
| VI1521A0 | STAINLESS STEEL WASHER D=6 6592 | 1.000 | PC | | | | | | | | | | | | | | | | | | | | | | | | | | | | | | | |
| VN1181A0 | M6 NUT 39 BLADES H81 D196 FAN | 1.000 | PC | | | | | | | | | | | | | | | | | | | | | | | | | | | | | | | |
| KVN1030A | LUX ≤08.2017S.5/S.5E D196 FAN KIT | <table border="1"> <thead> <tr> <th>Code</th> <th>Description</th> <th>Qty</th> <th>UOM</th> </tr> </thead> <tbody> <tr> <td>VI1256A0</td> <td>M8 DIN 980M ST. STEEL SELF LOCKING NUT</td> <td>1.000</td> <td>PC</td> </tr> <tr> <td>VM2196A0</td> <td>MOTOR NUT FASTENING BUSHING</td> <td>1.000</td> <td>PC</td> </tr> <tr> <td>VN1030A5</td> <td>Ø196 H81 38 BLADES MOTOR FAN</td> <td>1.000</td> <td>PC</td> </tr> </tbody> </table> | Code | Description | Qty | UOM | VI1256A0 | M8 DIN 980M ST. STEEL SELF LOCKING NUT | 1.000 | PC | VM2196A0 | MOTOR NUT FASTENING BUSHING | 1.000 | PC | VN1030A5 | Ø196 H81 38 BLADES MOTOR FAN | 1.000 | PC | | | | | | | | | | | | | | | | |
| Code | Description | Qty | UOM | | | | | | | | | | | | | | | | | | | | | | | | | | | | | | | |
| VI1256A0 | M8 DIN 980M ST. STEEL SELF LOCKING NUT | 1.000 | PC | | | | | | | | | | | | | | | | | | | | | | | | | | | | | | | |
| VM2196A0 | MOTOR NUT FASTENING BUSHING | 1.000 | PC | | | | | | | | | | | | | | | | | | | | | | | | | | | | | | | |
| VN1030A5 | Ø196 H81 38 BLADES MOTOR FAN | 1.000 | PC | | | | | | | | | | | | | | | | | | | | | | | | | | | | | | | |

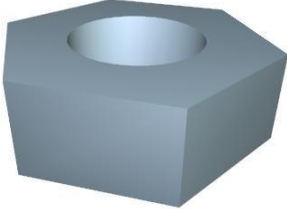
| COMPONENT | | | SPARE PART | | | | | | | | | | | | | | | | | | | | | | |
|-----------|---|---|------------|--|--|---|-------------|-----|-----|-----------|---------------------------------|--------|----|----------|---|-------|----|----------|-------------------------------------|-------|----|----------|-------------------------------|-------|----|
| Code | Description | Image | Code | Description | Kit components | | | | | | | | | | | | | | | | | | | | |
| RS1284A | 3200W 230V+400W 190V 4TURNS H80 ELEMENT |  | KRS1284A | 4TURN 3200W 230V+400W 190V HEAT ELEM KIT | <table border="1"> <thead> <tr> <th>Code</th> <th>Description</th> <th>Qty</th> <th>UOM</th> </tr> </thead> <tbody> <tr> <td>GN1327A0</td> <td>HEATING ELEMENT GASKET</td> <td>1.000</td> <td>PC</td> </tr> <tr> <td>RS1284A0</td> <td>3200W 230V+400W 190V 4TURNS H80 ELEMENT</td> <td>1.000</td> <td>PC</td> </tr> <tr> <td>SL1045A0</td> <td>S57 BLACK SILICONE - 80ml CARTRIDGE</td> <td>1.000</td> <td>PC</td> </tr> <tr> <td>VI1220A1</td> <td>4,2x12 TCB SELF-TAPPING SCREW</td> <td>2.000</td> <td>PC</td> </tr> </tbody> </table> | Code | Description | Qty | UOM | GN1327A0 | HEATING ELEMENT GASKET | 1.000 | PC | RS1284A0 | 3200W 230V+400W 190V 4TURNS H80 ELEMENT | 1.000 | PC | SL1045A0 | S57 BLACK SILICONE - 80ml CARTRIDGE | 1.000 | PC | VI1220A1 | 4,2x12 TCB SELF-TAPPING SCREW | 2.000 | PC |
| | | | | | Code | Description | Qty | UOM | | | | | | | | | | | | | | | | | |
| | | | | | GN1327A0 | HEATING ELEMENT GASKET | 1.000 | PC | | | | | | | | | | | | | | | | | |
| | | | | | RS1284A0 | 3200W 230V+400W 190V 4TURNS H80 ELEMENT | 1.000 | PC | | | | | | | | | | | | | | | | | |
| SL1045A0 | S57 BLACK SILICONE - 80ml CARTRIDGE | 1.000 | PC | | | | | | | | | | | | | | | | | | | | | | |
| VI1220A1 | 4,2x12 TCB SELF-TAPPING SCREW | 2.000 | PC | | | | | | | | | | | | | | | | | | | | | | |
| | | | | | | | | | | | | | | | | | | | | | | | | | |
| | | | | | | | | | | | | | | | | | | | | | | | | | |
| | | | | | | | | | | | | | | | | | | | | | | | | | |
| GRL1015A | L/R CHROMIUM PLATED LAT.SUPPORT |  | KGRL1015A | R/L 3 600x400 LM ELENA LATERAL SUPP KIT | <table border="1"> <thead> <tr> <th>Code</th> <th>Description</th> <th>Qty</th> <th>UOM</th> </tr> </thead> <tbody> <tr> <td>GRL1015A0</td> <td>L/R CHROMIUM PLATED LAT.SUPPORT</td> <td>2.000</td> <td>PC</td> </tr> </tbody> </table> | Code | Description | Qty | UOM | GRL1015A0 | L/R CHROMIUM PLATED LAT.SUPPORT | 2.000 | PC | | | | | | | | | | | | |
| | | | | | Code | Description | Qty | UOM | | | | | | | | | | | | | | | | | |
| GRL1015A0 | L/R CHROMIUM PLATED LAT.SUPPORT | 2.000 | PC | | | | | | | | | | | | | | | | | | | | | | |
| | | | | | | | | | | | | | | | | | | | | | | | | | |
| VM1815A | LATERAL SUPPORTS FIXING BOLT |  | KVM1815A | MISS/MICRO/S4/S3 THUMB SCREW 10 PCS KIT | <table border="1"> <thead> <tr> <th>Code</th> <th>Description</th> <th>Qty</th> <th>UOM</th> </tr> </thead> <tbody> <tr> <td>VM1815A0</td> <td>LATERAL SUPPORTS FIXING BOLT</td> <td>10.000</td> <td>PC</td> </tr> </tbody> </table> | Code | Description | Qty | UOM | VM1815A0 | LATERAL SUPPORTS FIXING BOLT | 10.000 | PC | | | | | | | | | | | | |
| | | | | | Code | Description | Qty | UOM | | | | | | | | | | | | | | | | | |
| VM1815A0 | LATERAL SUPPORTS FIXING BOLT | 10.000 | PC | | | | | | | | | | | | | | | | | | | | | | |
| | | | | | | | | | | | | | | | | | | | | | | | | | |
| GN1597A | GN1110A - SHOP.PRO ELENA DOOR GASKET |  | KGN1597A | BL SHOP.PRO ELENA DOOR GASKET KIT | <table border="1"> <thead> <tr> <th>Code</th> <th>Description</th> <th>Qty</th> <th>UOM</th> </tr> </thead> <tbody> <tr> <td>GN1597A1</td> <td></td> <td>1.000</td> <td>PC</td> </tr> <tr> <td>VM2277A0</td> <td>DOOR SEAL KIT INTERNAL CONNECTION</td> <td>1.000</td> <td>PC</td> </tr> </tbody> </table> | Code | Description | Qty | UOM | GN1597A1 | | 1.000 | PC | VM2277A0 | DOOR SEAL KIT INTERNAL CONNECTION | 1.000 | PC | | | | | | | | |
| | | | | | Code | Description | Qty | UOM | | | | | | | | | | | | | | | | | |
| GN1597A1 | | 1.000 | PC | | | | | | | | | | | | | | | | | | | | | | |
| VM2277A0 | DOOR SEAL KIT INTERNAL CONNECTION | 1.000 | PC | | | | | | | | | | | | | | | | | | | | | | |
| | | | | | | | | | | | | | | | | | | | | | | | | | |



| COMPONENT | | | SPARE PART | | | | | | | | | | |
|-----------|---|---|------------|---|---|------|-------------|-----|-----|----------|--|--------|----|
| Code | Description | Image | Code | Description | Kit components | | | | | | | | |
| RC1170A | M14 H=7 CH=22 STAINLESS STEEL NUT |  | KRC1170A | M14 H8 CH22 NUT - 10 PCS. KIT | <table border="1"> <thead> <tr> <th>Code</th> <th>Description</th> <th>Qty</th> <th>UOM</th> </tr> </thead> <tbody> <tr> <td>RC1170A1</td> <td>M14 H=7 CH=22 STAINLESS STEEL NUT</td> <td>10.000</td> <td>PC</td> </tr> </tbody> </table> | Code | Description | Qty | UOM | RC1170A1 | M14 H=7 CH=22 STAINLESS STEEL NUT | 10.000 | PC |
| Code | Description | Qty | UOM | | | | | | | | | | |
| RC1170A1 | M14 H=7 CH=22 STAINLESS STEEL NUT | 10.000 | PC | | | | | | | | | | |
| TB1574A | FUME CHIMNEY D30 SHOP PRO |  | TB1574A0 | FUME CHIMNEY D30 SHOP PRO | | | | | | | | | |
| TB1579A | ELENA SHOP PRO INTERNAL HUMIDITY PIPE |  | TB1579A0 | ELENA SHOP PRO INTERNAL HUMIDITY PIPE | | | | | | | | | |
| TB1638A | ELE-VIT-CAM SP WELDED EXT HUMIDITY PIPE |  | TB1638A0 | ELE-VIT-CAM SP WELDED EXT HUMIDITY PIPE | | | | | | | | | |
| VM2331A | FAN GUARD-TRAYS HOLDER PIN |  | KVM2331A | FAN GUARD-TRAYS HOLDER PIN 4 PCS KIT | <table border="1"> <thead> <tr> <th>Code</th> <th>Description</th> <th>Qty</th> <th>UOM</th> </tr> </thead> <tbody> <tr> <td>VM2331A0</td> <td>FAN GUARD-TRAY S HOLDER PIN</td> <td>4.000</td> <td>PC</td> </tr> </tbody> </table> | Code | Description | Qty | UOM | VM2331A0 | FAN GUARD-TRAY S HOLDER PIN | 4.000 | PC |
| Code | Description | Qty | UOM | | | | | | | | | | |
| VM2331A0 | FAN GUARD-TRAY S HOLDER PIN | 4.000 | PC | | | | | | | | | | |



ASM3415A/0.D01 - External cover - FRONT







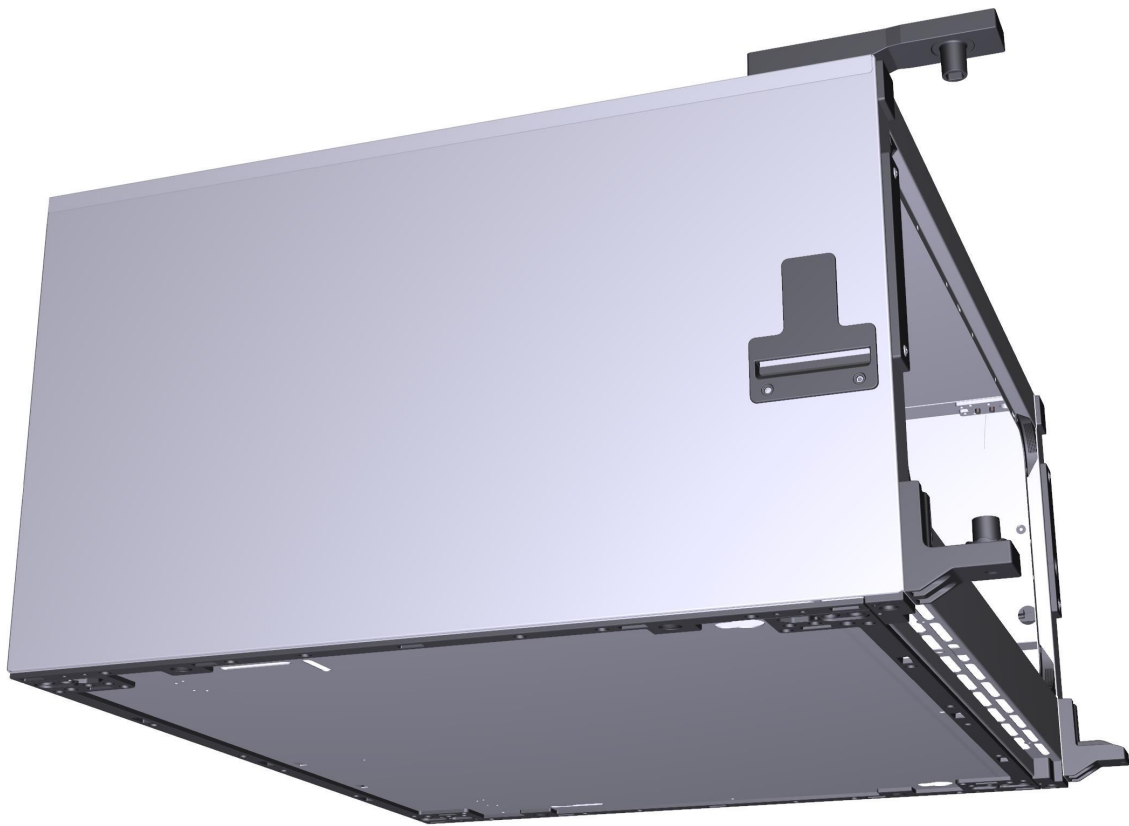





ASM3415A/0.D01 - External cover - REAR

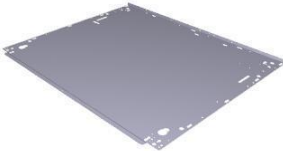







| COMPONENT | | | SPARE PART | | |
|-----------|---|---|------------|---|----------------|
| Code | Description | Image | Code | Description | Kit components |
| 0D2412A | SP800 INF FRONT PROFILE RIGHT-LEFT DOOR |  | 0D2412A1 | SP800 INF FRONT PROFILE RIGHT-LEFT DOOR | |
| 0D2414A | SP800 COVER |  | 0D2414A1 | SP800 COVER | |
| 0D2415B | ELENA SHOP PRO LEFT SIDE |  | 0D2415B0 | ELENA SHOP PRO LEFT SIDE | |
| 0D2416B | ELENA SHOP PRO RIGHT SIDE |  | 0D2416B0 | ELENA SHOP PRO RIGHT SIDE | |
| 0E1382A | SHOP.Pro800 EXTERNAL BOTTOM PANEL |  | 0E1382A2 | SHOP.Pro800 EXTERNAL BOTTOM PANEL | |



| COMPONENT | | | SPARE PART | | | | | | | | | | | | | | | | | | | | | | |
|-----------|--|---|------------|--|---|------|-------------|-----|-----|----------|--|-------|----|----------|----------------------------|-------|----|----------|-------------------------------|-------|----|----------|-------------------------------|-------|----|
| Code | Description | Image | Code | Description | Kit components | | | | | | | | | | | | | | | | | | | | |
| 0F1543B | ELENA SP BACK PANEL |  | 0F1543B0 | ELENA SP BACK PANEL | | | | | | | | | | | | | | | | | | | | | |
| 0H7991A | 0H7991A1 |  | K0H7991A | STE-ELE SP RIGHT LOCKING VENTILATION KIT | <table border="1"> <thead> <tr> <th>Code</th> <th>Description</th> <th>Qty</th> <th>UOM</th> </tr> </thead> <tbody> <tr> <td>0H7909A1</td> <td></td> <td>1.000</td> <td>PC</td> </tr> </tbody> </table> | Code | Description | Qty | UOM | 0H7909A1 | | 1.000 | PC | | | | | | | | | | | | |
| Code | Description | Qty | UOM | | | | | | | | | | | | | | | | | | | | | | |
| 0H7909A1 | | 1.000 | PC | | | | | | | | | | | | | | | | | | | | | | |
| 0H7995A | 0H7995A1 |  | 0H7995A1 | 0H7995A1 | | | | | | | | | | | | | | | | | | | | | |
| VM1750A | BRASS COMB CLAM |  | KVM1750A | COMB TERMINAL BLOCK KIT | <table border="1"> <thead> <tr> <th>Code</th> <th>Description</th> <th>Qty</th> <th>UOM</th> </tr> </thead> <tbody> <tr> <td>VI1040A0</td> <td>INDENTED INTERNAL WASHER D=6 ZN</td> <td>2.000</td> <td>PC</td> </tr> <tr> <td>VM1750A0</td> <td>BRASS COMB CLAMP</td> <td>1.000</td> <td>PC</td> </tr> </tbody> </table> | Code | Description | Qty | UOM | VI1040A0 | INDENTED INTERNAL WASHER D=6 ZN | 2.000 | PC | VM1750A0 | BRASS COMB CLAMP | 1.000 | PC | | | | | | | | |
| Code | Description | Qty | UOM | | | | | | | | | | | | | | | | | | | | | | |
| VI1040A0 | INDENTED INTERNAL WASHER D=6 ZN | 2.000 | PC | | | | | | | | | | | | | | | | | | | | | | |
| VM1750A0 | BRASS COMB CLAMP | 1.000 | PC | | | | | | | | | | | | | | | | | | | | | | |
| CE1297A | BLSP ELECTROMECHANICAL LOCK CABLE |  | KCE1297A | BL SHOP.PRO CABLE LOCK KIT | <table border="1"> <thead> <tr> <th>Code</th> <th>Description</th> <th>Qty</th> <th>UOM</th> </tr> </thead> <tbody> <tr> <td>CE1295A1</td> <td>CABLE FOR ELECTROMAGNETIC LOCKING SYSTEM</td> <td>1.000</td> <td>PC</td> </tr> <tr> <td>CE1735A0</td> <td>MINIFIT FEMALE END FITTING</td> <td>4.000</td> <td>PC</td> </tr> <tr> <td>CE1746A0</td> <td>2 WAYS MALE MINIFIT CONNECTOR</td> <td>1.000</td> <td>PC</td> </tr> <tr> <td>CE1750A0</td> <td>3 WAYS MALE MINIFIT CONNECTOR</td> <td>1.000</td> <td>PC</td> </tr> </tbody> </table> | Code | Description | Qty | UOM | CE1295A1 | CABLE FOR ELECTROMAGNETIC LOCKING SYSTEM | 1.000 | PC | CE1735A0 | MINIFIT FEMALE END FITTING | 4.000 | PC | CE1746A0 | 2 WAYS MALE MINIFIT CONNECTOR | 1.000 | PC | CE1750A0 | 3 WAYS MALE MINIFIT CONNECTOR | 1.000 | PC |
| Code | Description | Qty | UOM | | | | | | | | | | | | | | | | | | | | | | |
| CE1295A1 | CABLE FOR ELECTROMAGNETIC LOCKING SYSTEM | 1.000 | PC | | | | | | | | | | | | | | | | | | | | | | |
| CE1735A0 | MINIFIT FEMALE END FITTING | 4.000 | PC | | | | | | | | | | | | | | | | | | | | | | |
| CE1746A0 | 2 WAYS MALE MINIFIT CONNECTOR | 1.000 | PC | | | | | | | | | | | | | | | | | | | | | | |
| CE1750A0 | 3 WAYS MALE MINIFIT CONNECTOR | 1.000 | PC | | | | | | | | | | | | | | | | | | | | | | |





| COMPONENT | | | SPARE PART | | | | | | | | | | | | | | | | | | | | | | |
|-----------|---|---|------------|--|--|------|-------------|-----|-----|-----------|---------------------------------------|-------|----|----------|---|-------|----|----------|---------------------------------------|-------|----|----------|-------------------|-------|----|
| Code | Description | Image | Code | Description | Kit components | | | | | | | | | | | | | | | | | | | | |
| 0H1234A | 0H1234A2 |  | K0H1234A | SHOP.PRO LOCK HOLDING PLATE KIT | <table border="1"> <thead> <tr> <th>Code</th> <th>Description</th> <th>Qty</th> <th>UOM</th> </tr> </thead> <tbody> <tr> <td>0H1234A2</td> <td>0H1234A2</td> <td>1.000</td> <td>PC</td> </tr> <tr> <td>VI1014A0</td> <td>STAINLESS STEEL WASHER 4.5X9X0.8</td> <td>2.000</td> <td>PC</td> </tr> <tr> <td>VI1024A0</td> <td>SCREW M4x12 TCB + INOX DIN 7985</td> <td>2.000</td> <td>PC</td> </tr> <tr> <td>VI1850A0</td> <td>TCB M4x6 SCREW</td> <td>2.000</td> <td>PC</td> </tr> </tbody> </table> | Code | Description | Qty | UOM | 0H1234A2 | 0H1234A2 | 1.000 | PC | VI1014A0 | STAINLESS STEEL WASHER 4.5X9X0.8 | 2.000 | PC | VI1024A0 | SCREW M4x12 TCB + INOX DIN 7985 | 2.000 | PC | VI1850A0 | TCB M4x6 SCREW | 2.000 | PC |
| Code | Description | Qty | UOM | | | | | | | | | | | | | | | | | | | | | | |
| 0H1234A2 | 0H1234A2 | 1.000 | PC | | | | | | | | | | | | | | | | | | | | | | |
| VI1014A0 | STAINLESS STEEL WASHER 4.5X9X0.8 | 2.000 | PC | | | | | | | | | | | | | | | | | | | | | | |
| VI1024A0 | SCREW M4x12 TCB + INOX DIN 7985 | 2.000 | PC | | | | | | | | | | | | | | | | | | | | | | |
| VI1850A0 | TCB M4x6 SCREW | 2.000 | PC | | | | | | | | | | | | | | | | | | | | | | |
| CR1035A | L.Miss Matic ELECTROMECHANICAL LOCK |  | KCR1035A | LM MATIC ELECTROMECHANICAL LOCK KIT | <table border="1"> <thead> <tr> <th>Code</th> <th>Description</th> <th>Qty</th> <th>UOM</th> </tr> </thead> <tbody> <tr> <td>0H10283A0</td> <td></td> <td>1.000</td> <td>PC</td> </tr> <tr> <td>CR1035A0</td> <td>L.Miss Matic ELECTROMECHANICAL LOCK</td> <td>1.000</td> <td>PC</td> </tr> </tbody> </table> | Code | Description | Qty | UOM | 0H10283A0 | | 1.000 | PC | CR1035A0 | L.Miss Matic ELECTROMECHANICAL LOCK | 1.000 | PC | | | | | | | | |
| Code | Description | Qty | UOM | | | | | | | | | | | | | | | | | | | | | | |
| 0H10283A0 | | 1.000 | PC | | | | | | | | | | | | | | | | | | | | | | |
| CR1035A0 | L.Miss Matic ELECTROMECHANICAL LOCK | 1.000 | PC | | | | | | | | | | | | | | | | | | | | | | |
| VM2154A | VM2154A2 |  | KVM2154A | LINEMISS MATIC-TOP LOCKING COVER KIT | <table border="1"> <thead> <tr> <th>Code</th> <th>Description</th> <th>Qty</th> <th>UOM</th> </tr> </thead> <tbody> <tr> <td>0H1234A2</td> <td>0H1234A2</td> <td>1.000</td> <td>PC</td> </tr> <tr> <td>VM2154A2</td> <td>VM2154A2</td> <td>1.000</td> <td>PC</td> </tr> </tbody> </table> | Code | Description | Qty | UOM | 0H1234A2 | 0H1234A2 | 1.000 | PC | VM2154A2 | VM2154A2 | 1.000 | PC | | | | | | | | |
| Code | Description | Qty | UOM | | | | | | | | | | | | | | | | | | | | | | |
| 0H1234A2 | 0H1234A2 | 1.000 | PC | | | | | | | | | | | | | | | | | | | | | | |
| VM2154A2 | VM2154A2 | 1.000 | PC | | | | | | | | | | | | | | | | | | | | | | |
| VM2290A | ELECTRIC LOCKING BLIND COVER |  | KVM2290A | BLSP BLIND LOCKING COVER KIT | <table border="1"> <thead> <tr> <th>Code</th> <th>Description</th> <th>Qty</th> <th>UOM</th> </tr> </thead> <tbody> <tr> <td>VI1024A0</td> <td>SCREW M4x12 TCB + INOX DIN 7985</td> <td>2.000</td> <td>PC</td> </tr> <tr> <td>VM2290A0</td> <td>ELECTRIC LOCKING BLIND COVER</td> <td>1.000</td> <td>PC</td> </tr> </tbody> </table> | Code | Description | Qty | UOM | VI1024A0 | SCREW M4x12 TCB + INOX DIN 7985 | 2.000 | PC | VM2290A0 | ELECTRIC LOCKING BLIND COVER | 1.000 | PC | | | | | | | | |
| Code | Description | Qty | UOM | | | | | | | | | | | | | | | | | | | | | | |
| VI1024A0 | SCREW M4x12 TCB + INOX DIN 7985 | 2.000 | PC | | | | | | | | | | | | | | | | | | | | | | |
| VM2290A0 | ELECTRIC LOCKING BLIND COVER | 1.000 | PC | | | | | | | | | | | | | | | | | | | | | | |
| VM2502A | BAKERLUX SHOP.PRO CHIMNEY RING |  | KVM2502A | BAKERLUX SHOP.PRO CHIMNEY RING KIT | <table border="1"> <thead> <tr> <th>Code</th> <th>Description</th> <th>Qty</th> <th>UOM</th> </tr> </thead> <tbody> <tr> <td>VM2502A0</td> <td>BAKERLUX SHOP.PRO CHIMNEY RING</td> <td>1.000</td> <td>PC</td> </tr> </tbody> </table> | Code | Description | Qty | UOM | VM2502A0 | BAKERLUX SHOP.PRO CHIMNEY RING | 1.000 | PC | | | | | | | | | | | | |
| Code | Description | Qty | UOM | | | | | | | | | | | | | | | | | | | | | | |
| VM2502A0 | BAKERLUX SHOP.PRO CHIMNEY RING | 1.000 | PC | | | | | | | | | | | | | | | | | | | | | | |



| COMPONENT | | | SPARE PART | | | | | | | | | | | | | | | | | | | | | | |
|-----------|---|---|------------|--|--|------|-------------|-----|-----|----------|---------------------------------------|-------|----|----------|---|-------|----|----------|----------------------------------|-------|----|----------|--------------------------|-------|----|
| Code | Description | Image | Code | Description | Kit components | | | | | | | | | | | | | | | | | | | | |
| VM2495A | SP COOLING FAN SUPPORT |  | KVM2495A | COOLING FAN SUPPORT KIT | <table border="1"> <thead> <tr> <th>Code</th> <th>Description</th> <th>Qty</th> <th>UOM</th> </tr> </thead> <tbody> <tr> <td>V11220A1</td> <td>4,2x12 TCB SELF-TAPPIN G SCREW</td> <td>2.000</td> <td>PC</td> </tr> <tr> <td>VM2495A0</td> <td>SP COOLING FAN SUPPORT</td> <td>1.000</td> <td>PC</td> </tr> </tbody> </table> | Code | Description | Qty | UOM | V11220A1 | 4,2x12 TCB SELF-TAPPIN G SCREW | 2.000 | PC | VM2495A0 | SP COOLING FAN SUPPORT | 1.000 | PC | | | | | | | | |
| Code | Description | Qty | UOM | | | | | | | | | | | | | | | | | | | | | | |
| V11220A1 | 4,2x12 TCB SELF-TAPPIN G SCREW | 2.000 | PC | | | | | | | | | | | | | | | | | | | | | | |
| VM2495A0 | SP COOLING FAN SUPPORT | 1.000 | PC | | | | | | | | | | | | | | | | | | | | | | |
| VN1175A | 230V 50/60Hz 120x120 COOLING DOWN FAN |  | KVN1175A | 120x120 230V 50/60Hz COOLING FAN KIT | <table border="1"> <thead> <tr> <th>Code</th> <th>Description</th> <th>Qty</th> <th>UOM</th> </tr> </thead> <tbody> <tr> <td>VN1175A0</td> <td>230V 50/60Hz 120x120 COOLING DOWN FAN</td> <td>1.000</td> <td>PC</td> </tr> </tbody> </table> | Code | Description | Qty | UOM | VN1175A0 | 230V 50/60Hz 120x120 COOLING DOWN FAN | 1.000 | PC | | | | | | | | | | | | |
| Code | Description | Qty | UOM | | | | | | | | | | | | | | | | | | | | | | |
| VN1175A0 | 230V 50/60Hz 120x120 COOLING DOWN FAN | 1.000 | PC | | | | | | | | | | | | | | | | | | | | | | |
| VM2481A | FRONT EXTERNAL COVER LEFT CAP S |  | KVM2481A | BL SP LEFT EXT COVER FRONT PANEL CAP KIT | <table border="1"> <thead> <tr> <th>Code</th> <th>Description</th> <th>Qty</th> <th>UOM</th> </tr> </thead> <tbody> <tr> <td>VM2481A0</td> <td>FRONT EXTERNAL COVER LEFT CAP SP</td> <td>1.000</td> <td>PC</td> </tr> </tbody> </table> | Code | Description | Qty | UOM | VM2481A0 | FRONT EXTERNAL COVER LEFT CAP SP | 1.000 | PC | | | | | | | | | | | | |
| Code | Description | Qty | UOM | | | | | | | | | | | | | | | | | | | | | | |
| VM2481A0 | FRONT EXTERNAL COVER LEFT CAP SP | 1.000 | PC | | | | | | | | | | | | | | | | | | | | | | |
| VM2480A | FRONT EXTERNAL COVER RIGHT CAP SP |  | KVM2480A | BL SP RIGHT EXT COVER FRONT PANEL CAP | <table border="1"> <thead> <tr> <th>Code</th> <th>Description</th> <th>Qty</th> <th>UOM</th> </tr> </thead> <tbody> <tr> <td>VM2480A0</td> <td>FRONT EXTERNAL COVER RIGHT CAP SP</td> <td>1.000</td> <td>PC</td> </tr> </tbody> </table> | Code | Description | Qty | UOM | VM2480A0 | FRONT EXTERNAL COVER RIGHT CAP SP | 1.000 | PC | | | | | | | | | | | | |
| Code | Description | Qty | UOM | | | | | | | | | | | | | | | | | | | | | | |
| VM2480A0 | FRONT EXTERNAL COVER RIGHT CAP SP | 1.000 | PC | | | | | | | | | | | | | | | | | | | | | | |
| VM2488A | BL SHOP.PRO MANUAL UNLOCK SYSTEM |  | KVM2488A | BL SHOP.PRO MANUAL UNLOCK SYSTEM KIT | <table border="1"> <thead> <tr> <th>Code</th> <th>Description</th> <th>Qty</th> <th>UOM</th> </tr> </thead> <tbody> <tr> <td>V11220A1</td> <td>4,2x12 TCB SELF-TAPPIN G SCREW</td> <td>2.000</td> <td>PC</td> </tr> <tr> <td>V11950A0</td> <td>ST. STEEL 4,2X13 TCB SELF-DRILLIN G SCREW</td> <td>2.000</td> <td>PC</td> </tr> <tr> <td>VM2488A1</td> <td>BL SHOP.PRO MANUAL UNLOCK SYSTEM</td> <td>1.000</td> <td>PC</td> </tr> <tr> <td>VM2501A0</td> <td>BL SHOP.PRO UNLOCK SCREW</td> <td>1.000</td> <td>PC</td> </tr> </tbody> </table> | Code | Description | Qty | UOM | V11220A1 | 4,2x12 TCB SELF-TAPPIN G SCREW | 2.000 | PC | V11950A0 | ST. STEEL 4,2X13 TCB SELF-DRILLIN G SCREW | 2.000 | PC | VM2488A1 | BL SHOP.PRO MANUAL UNLOCK SYSTEM | 1.000 | PC | VM2501A0 | BL SHOP.PRO UNLOCK SCREW | 1.000 | PC |
| Code | Description | Qty | UOM | | | | | | | | | | | | | | | | | | | | | | |
| V11220A1 | 4,2x12 TCB SELF-TAPPIN G SCREW | 2.000 | PC | | | | | | | | | | | | | | | | | | | | | | |
| V11950A0 | ST. STEEL 4,2X13 TCB SELF-DRILLIN G SCREW | 2.000 | PC | | | | | | | | | | | | | | | | | | | | | | |
| VM2488A1 | BL SHOP.PRO MANUAL UNLOCK SYSTEM | 1.000 | PC | | | | | | | | | | | | | | | | | | | | | | |
| VM2501A0 | BL SHOP.PRO UNLOCK SCREW | 1.000 | PC | | | | | | | | | | | | | | | | | | | | | | |



| COMPONENT | | | SPARE PART | | | | | | | | | | | | | | | | | | | | | | |
|-----------|--|---|------------|---------------------------------------|---|------|-------------|-----|-----|----------|---------------------------------|-------|----|----------|----------------------|-------|----|----------|-------------------------------|-------|----|----------|--|-------|----|
| Code | Description | Image | Code | Description | Kit components | | | | | | | | | | | | | | | | | | | | |
| 0H7850A | SHOP PRO DOOR COUNTERBRACKET |  | 0H7850A0 | SHOP PRO DOOR COUNTERBRACKET | | | | | | | | | | | | | | | | | | | | | |
| VI0515A | STAINLESS STEEL WASHER D=5 6592 |  | VI0515A0 | STAINLESS STEEL WASHER D=5 6592 | | | | | | | | | | | | | | | | | | | | | |
| VI1995A | M5x25 ST.STEEL SCREW |  | VI1995A0 | M5x25 ST.STEEL SCREW | | | | | | | | | | | | | | | | | | | | | |
| VM1240A | NYLON SUPPORT CAP |  | KVM1240A | 4 PCS COUNTER BRACKET SUPPORT CAP KIT | <table border="1"> <thead> <tr> <th>Code</th> <th>Description</th> <th>Qty</th> <th>UOM</th> </tr> </thead> <tbody> <tr> <td>VM1240A0</td> <td>NYLON SUPPORT CAP</td> <td>4.000</td> <td>PC</td> </tr> </tbody> </table> | Code | Description | Qty | UOM | VM1240A0 | NYLON SUPPORT CAP | 4.000 | PC | | | | | | | | | | | | |
| Code | Description | Qty | UOM | | | | | | | | | | | | | | | | | | | | | | |
| VM1240A0 | NYLON SUPPORT CAP | 4.000 | PC | | | | | | | | | | | | | | | | | | | | | | |
| VM2459A | SP LATERAL DOOR UPPER BRACKET |  | KVM2459A | BL SP LATERAL DOOR UPPER BRACKET KIT | <table border="1"> <thead> <tr> <th>Code</th> <th>Description</th> <th>Qty</th> <th>UOM</th> </tr> </thead> <tbody> <tr> <td>VI0515A0</td> <td>STAINLESS STEEL WASHER D=5 6592</td> <td>4.000</td> <td>PC</td> </tr> <tr> <td>VI1995A0</td> <td>M5x25 ST.STEEL SCREW</td> <td>4.000</td> <td>PC</td> </tr> <tr> <td>VM2459A1</td> <td>SP LATERAL DOOR UPPER BRACKET</td> <td>1.000</td> <td>PC</td> </tr> <tr> <td>VM2460A0</td> <td>BL SP LATERAL DOOR UPPER BRACKET COVER</td> <td>1.000</td> <td>PC</td> </tr> </tbody> </table> | Code | Description | Qty | UOM | VI0515A0 | STAINLESS STEEL WASHER D=5 6592 | 4.000 | PC | VI1995A0 | M5x25 ST.STEEL SCREW | 4.000 | PC | VM2459A1 | SP LATERAL DOOR UPPER BRACKET | 1.000 | PC | VM2460A0 | BL SP LATERAL DOOR UPPER BRACKET COVER | 1.000 | PC |
| Code | Description | Qty | UOM | | | | | | | | | | | | | | | | | | | | | | |
| VI0515A0 | STAINLESS STEEL WASHER D=5 6592 | 4.000 | PC | | | | | | | | | | | | | | | | | | | | | | |
| VI1995A0 | M5x25 ST.STEEL SCREW | 4.000 | PC | | | | | | | | | | | | | | | | | | | | | | |
| VM2459A1 | SP LATERAL DOOR UPPER BRACKET | 1.000 | PC | | | | | | | | | | | | | | | | | | | | | | |
| VM2460A0 | BL SP LATERAL DOOR UPPER BRACKET COVER | 1.000 | PC | | | | | | | | | | | | | | | | | | | | | | |



| COMPONENT | | | SPARE PART | | | | | | | | | | | | | | | | | | | | | | |
|-----------|--|---|------------|--|--|------|-------------|-----|-----|----------|--|-------|----|----------|----------------------|-------|----|----------|----------------------------------|-------|----|----------|--------------------------------------|-------|----|
| Code | Description | Image | Code | Description | Kit components | | | | | | | | | | | | | | | | | | | | |
| VM2460A | BL SP LATERAL DOOR UPPER BRACKET COVER |  | KVM2460A | BL SP LAT DOOR UPP BRACKET COVER 2PC KIT | <table border="1"> <thead> <tr> <th>Code</th> <th>Description</th> <th>Qty</th> <th>UOM</th> </tr> </thead> <tbody> <tr> <td>VM2460A0</td> <td>BL SP LATERAL DOOR UPPER BRACKET COVER</td> <td>1.000</td> <td>PC</td> </tr> </tbody> </table> | Code | Description | Qty | UOM | VM2460A0 | BL SP LATERAL DOOR UPPER BRACKET COVER | 1.000 | PC | | | | | | | | | | | | |
| Code | Description | Qty | UOM | | | | | | | | | | | | | | | | | | | | | | |
| VM2460A0 | BL SP LATERAL DOOR UPPER BRACKET COVER | 1.000 | PC | | | | | | | | | | | | | | | | | | | | | | |
| 0H7850A | SHOP PRO DOOR COUNTERBRACKET |  | 0H7850A0 | SHOP PRO DOOR COUNTERBRACKET | | | | | | | | | | | | | | | | | | | | | |
| VI0515A | STAINLESS STEEL WASHER D=5 6592 |  | VI0515A0 | STAINLESS STEEL WASHER D=5 6592 | | | | | | | | | | | | | | | | | | | | | |
| VM1240A | NYLON SUPPORT CAP |  | KVM1240A | 4 PCS COUNTER BRACKET SUPPORT CAP KIT | <table border="1"> <thead> <tr> <th>Code</th> <th>Description</th> <th>Qty</th> <th>UOM</th> </tr> </thead> <tbody> <tr> <td>VM1240A0</td> <td>NYLON SUPPORT CAP</td> <td>4.000</td> <td>PC</td> </tr> </tbody> </table> | Code | Description | Qty | UOM | VM1240A0 | NYLON SUPPORT CAP | 4.000 | PC | | | | | | | | | | | | |
| Code | Description | Qty | UOM | | | | | | | | | | | | | | | | | | | | | | |
| VM1240A0 | NYLON SUPPORT CAP | 4.000 | PC | | | | | | | | | | | | | | | | | | | | | | |
| VM2457A | BL SP LATERAL DOOR LOWER BRACKET |  | KVM2457A | BL SP LATERAL DOOR LOWER BRACKET KIT | <table border="1"> <thead> <tr> <th>Code</th> <th>Description</th> <th>Qty</th> <th>UOM</th> </tr> </thead> <tbody> <tr> <td>VI0515A0</td> <td>STAINLESS STEEL WASHER D=5 6592</td> <td>2.000</td> <td>PC</td> </tr> <tr> <td>VI1995A0</td> <td>M5x25 ST.STEEL SCREW</td> <td>2.000</td> <td>PC</td> </tr> <tr> <td>VM2457A0</td> <td>BL SP LATERAL DOOR LOWER BRACKET</td> <td>1.000</td> <td>PC</td> </tr> <tr> <td>VM2458A0</td> <td>BL SP LATERAL DOOR LOW BRACKET COVER</td> <td>1.000</td> <td>PC</td> </tr> </tbody> </table> | Code | Description | Qty | UOM | VI0515A0 | STAINLESS STEEL WASHER D=5 6592 | 2.000 | PC | VI1995A0 | M5x25 ST.STEEL SCREW | 2.000 | PC | VM2457A0 | BL SP LATERAL DOOR LOWER BRACKET | 1.000 | PC | VM2458A0 | BL SP LATERAL DOOR LOW BRACKET COVER | 1.000 | PC |
| Code | Description | Qty | UOM | | | | | | | | | | | | | | | | | | | | | | |
| VI0515A0 | STAINLESS STEEL WASHER D=5 6592 | 2.000 | PC | | | | | | | | | | | | | | | | | | | | | | |
| VI1995A0 | M5x25 ST.STEEL SCREW | 2.000 | PC | | | | | | | | | | | | | | | | | | | | | | |
| VM2457A0 | BL SP LATERAL DOOR LOWER BRACKET | 1.000 | PC | | | | | | | | | | | | | | | | | | | | | | |
| VM2458A0 | BL SP LATERAL DOOR LOW BRACKET COVER | 1.000 | PC | | | | | | | | | | | | | | | | | | | | | | |



| COMPONENT | | | SPARE PART | | | | | | | | | | |
|-----------|--------------------------------------|---|------------|--|---|------|-------------|-----|-----|----------|--------------------------------------|-------|----|
| Code | Description | Image | Code | Description | Kit components | | | | | | | | |
| VM2458A | BL SP LATERAL DOOR LOW BRACKET COVER |  | KVM2458A | BL SP LAT DOOR LOW BRACKET COVER 2PC KIT | <table border="1"> <thead> <tr> <th>Code</th> <th>Description</th> <th>Qty</th> <th>UOM</th> </tr> </thead> <tbody> <tr> <td>VM2458A0</td> <td>BL SP LATERAL DOOR LOW BRACKET COVER</td> <td>2.000</td> <td>PC</td> </tr> </tbody> </table> | Code | Description | Qty | UOM | VM2458A0 | BL SP LATERAL DOOR LOW BRACKET COVER | 2.000 | PC |
| Code | Description | Qty | UOM | | | | | | | | | | |
| VM2458A0 | BL SP LATERAL DOOR LOW BRACKET COVER | 2.000 | PC | | | | | | | | | | |
| 0H7850A | SHOP PRO DOOR COUNTERBRACKET |  | 0H7850A0 | SHOP PRO DOOR COUNTERBRACKET | | | | | | | | | |
| VI0515A | STAINLESS STEEL WASHER D=5 6592 |  | VI0515A0 | STAINLESS STEEL WASHER D=5 6592 | | | | | | | | | |
| VM1240A | NYLON SUPPORT CAP |  | KVM1240A | 4 PCS COUNTER BRACKET SUPPORT CAP KIT | <table border="1"> <thead> <tr> <th>Code</th> <th>Description</th> <th>Qty</th> <th>UOM</th> </tr> </thead> <tbody> <tr> <td>VM1240A0</td> <td>NYLON SUPPORT CAP</td> <td>4.000</td> <td>PC</td> </tr> </tbody> </table> | Code | Description | Qty | UOM | VM1240A0 | NYLON SUPPORT CAP | 4.000 | PC |
| Code | Description | Qty | UOM | | | | | | | | | | |
| VM1240A0 | NYLON SUPPORT CAP | 4.000 | PC | | | | | | | | | | |
| VM2458A | BL SP LATERAL DOOR LOW BRACKET COVER |  | KVM2458A | BL SP LAT DOOR LOW BRACKET COVER 2PC KIT | <table border="1"> <thead> <tr> <th>Code</th> <th>Description</th> <th>Qty</th> <th>UOM</th> </tr> </thead> <tbody> <tr> <td>VM2458A0</td> <td>BL SP LATERAL DOOR LOW BRACKET COVER</td> <td>2.000</td> <td>PC</td> </tr> </tbody> </table> | Code | Description | Qty | UOM | VM2458A0 | BL SP LATERAL DOOR LOW BRACKET COVER | 2.000 | PC |
| Code | Description | Qty | UOM | | | | | | | | | | |
| VM2458A0 | BL SP LATERAL DOOR LOW BRACKET COVER | 2.000 | PC | | | | | | | | | | |





| COMPONENT | | | SPARE PART | | | | | | | | | | | | | | | | | | | | | | |
|-----------|--|---|------------|--|---|------|-------------|-----|-----|----------|---------------------------------|-------|----|----------|----------------------|-------|----|----------|--------------------------------------|-------|----|----------|-----------------------------------|-------|----|
| Code | Description | Image | Code | Description | Kit components | | | | | | | | | | | | | | | | | | | | |
| VM2469A | BL SP LATERAL DOOR HOLDER BRACKET |  | KVM2469A | BL SP LATERAL DOOR HOLDER BRACKET KIT | <table border="1"> <thead> <tr> <th>Code</th> <th>Description</th> <th>Qty</th> <th>UOM</th> </tr> </thead> <tbody> <tr> <td>VI0515A0</td> <td>STAINLESS STEEL WASHER D=5 6592</td> <td>2.000</td> <td>PC</td> </tr> <tr> <td>VI1995A0</td> <td>M5x25 ST.STEEL SCREW</td> <td>2.000</td> <td>PC</td> </tr> <tr> <td>VM2458A0</td> <td>BL SP LATERAL DOOR LOW BRACKET COVER</td> <td>1.000</td> <td>PC</td> </tr> <tr> <td>VM2469A0</td> <td>BL SP LATERAL DOOR HOLDER BRACKET</td> <td>1.000</td> <td>PC</td> </tr> </tbody> </table> | Code | Description | Qty | UOM | VI0515A0 | STAINLESS STEEL WASHER D=5 6592 | 2.000 | PC | VI1995A0 | M5x25 ST.STEEL SCREW | 2.000 | PC | VM2458A0 | BL SP LATERAL DOOR LOW BRACKET COVER | 1.000 | PC | VM2469A0 | BL SP LATERAL DOOR HOLDER BRACKET | 1.000 | PC |
| Code | Description | Qty | UOM | | | | | | | | | | | | | | | | | | | | | | |
| VI0515A0 | STAINLESS STEEL WASHER D=5 6592 | 2.000 | PC | | | | | | | | | | | | | | | | | | | | | | |
| VI1995A0 | M5x25 ST.STEEL SCREW | 2.000 | PC | | | | | | | | | | | | | | | | | | | | | | |
| VM2458A0 | BL SP LATERAL DOOR LOW BRACKET COVER | 1.000 | PC | | | | | | | | | | | | | | | | | | | | | | |
| VM2469A0 | BL SP LATERAL DOOR HOLDER BRACKET | 1.000 | PC | | | | | | | | | | | | | | | | | | | | | | |
| 0H7850A | SHOP PRO DOOR COUNTERBRACKET |  | 0H7850A0 | SHOP PRO DOOR COUNTERBRACKET | | | | | | | | | | | | | | | | | | | | | |
| VM1195A | HOLES BLANKING PLATE XVC204/304/504/704 |  | VM1195A0 | HOLES BLANKING PLATE XVC204/304/504/704 | | | | | | | | | | | | | | | | | | | | | |
| VM1240A | NYLON SUPPORT CAP |  | KVM1240A | 4 PCS COUNTER BRACKET SUPPORT CAP KIT | <table border="1"> <thead> <tr> <th>Code</th> <th>Description</th> <th>Qty</th> <th>UOM</th> </tr> </thead> <tbody> <tr> <td>VM1240A0</td> <td>NYLON SUPPORT CAP</td> <td>4.000</td> <td>PC</td> </tr> </tbody> </table> | Code | Description | Qty | UOM | VM1240A0 | NYLON SUPPORT CAP | 4.000 | PC | | | | | | | | | | | | |
| Code | Description | Qty | UOM | | | | | | | | | | | | | | | | | | | | | | |
| VM1240A0 | NYLON SUPPORT CAP | 4.000 | PC | | | | | | | | | | | | | | | | | | | | | | |



| COMPONENT | | | SPARE PART | | | | | | | | | | | | | | | | | | |
|-----------|--|--------|------------|--|---|------|-------------|-----|-----|----------|------------------------------|--------|----|----------|--------------------------------------|-------|----|----------|--------------------------------|-------|----|
| Code | Description | Image | Code | Description | Kit components | | | | | | | | | | | | | | | | |
| VM1631A | PLUS INNER GLASS PUSHING CAP | | KVM1631A | CAP FOR INTERNAL GLASS 10 PCS KIT | <table border="1"> <thead> <tr> <th>Code</th> <th>Description</th> <th>Qty</th> <th>UOM</th> </tr> </thead> <tbody> <tr> <td>VM1631A0</td> <td>PLUS INNER GLASS PUSHING CAP</td> <td>10.000</td> <td>PC</td> </tr> </tbody> </table> | Code | Description | Qty | UOM | VM1631A0 | PLUS INNER GLASS PUSHING CAP | 10.000 | PC | | | | | | | | |
| Code | Description | Qty | UOM | | | | | | | | | | | | | | | | | | |
| VM1631A0 | PLUS INNER GLASS PUSHING CAP | 10.000 | PC | | | | | | | | | | | | | | | | | | |
| VM2492A | BL SP 600x400 EXT BOTTOM PANEL GASKET | | KVM2492A | SP 600X400 EXT BOT PANEL GASKET 2PC KIT | <table border="1"> <thead> <tr> <th>Code</th> <th>Description</th> <th>Qty</th> <th>UOM</th> </tr> </thead> <tbody> <tr> <td>VM1794A0</td> <td>250x4.8 PA66 BLACK CLAMP</td> <td>1.000</td> <td>PC</td> </tr> <tr> <td>VM2492A0</td> <td>BL SP 600x400 EXT BOTTOM PANEL GASKE</td> <td>2.000</td> <td>PC</td> </tr> </tbody> </table> | Code | Description | Qty | UOM | VM1794A0 | 250x4.8 PA66 BLACK CLAMP | 1.000 | PC | VM2492A0 | BL SP 600x400 EXT BOTTOM PANEL GASKE | 2.000 | PC | | | | |
| Code | Description | Qty | UOM | | | | | | | | | | | | | | | | | | |
| VM1794A0 | 250x4.8 PA66 BLACK CLAMP | 1.000 | PC | | | | | | | | | | | | | | | | | | |
| VM2492A0 | BL SP 600x400 EXT BOTTOM PANEL GASKE | 2.000 | PC | | | | | | | | | | | | | | | | | | |
| VM2493A | EXT. LATERAL BACK GASKET SP800 | | KVM2493A | SP 600X400 BOT LAT PANEL GASKET 2PC KIT | <table border="1"> <thead> <tr> <th>Code</th> <th>Description</th> <th>Qty</th> <th>UOM</th> </tr> </thead> <tbody> <tr> <td>VM1631A0</td> <td>PLUS INNER GLASS PUSHING CAP</td> <td>4.000</td> <td>PC</td> </tr> <tr> <td>VM1794A0</td> <td>250x4.8 PA66 BLACK CLAMP</td> <td>1.000</td> <td>PC</td> </tr> <tr> <td>VM2493A1</td> <td>EXT. LATERAL BACK GASKET SP800</td> <td>2.000</td> <td>PC</td> </tr> </tbody> </table> | Code | Description | Qty | UOM | VM1631A0 | PLUS INNER GLASS PUSHING CAP | 4.000 | PC | VM1794A0 | 250x4.8 PA66 BLACK CLAMP | 1.000 | PC | VM2493A1 | EXT. LATERAL BACK GASKET SP800 | 2.000 | PC |
| Code | Description | Qty | UOM | | | | | | | | | | | | | | | | | | |
| VM1631A0 | PLUS INNER GLASS PUSHING CAP | 4.000 | PC | | | | | | | | | | | | | | | | | | |
| VM1794A0 | 250x4.8 PA66 BLACK CLAMP | 1.000 | PC | | | | | | | | | | | | | | | | | | |
| VM2493A1 | EXT. LATERAL BACK GASKET SP800 | 2.000 | PC | | | | | | | | | | | | | | | | | | |
| VM1222A | CABLE LOCKS SP ACCESSORIES EL CONNECTION | | VM1222A0 | CABLE LOCKS SP ACCESSORIES EL CONNECTION | | | | | | | | | | | | | | | | | |
| VM2249A | COOKING CHAMBER FRONT CORNER | | KVM2249A | CHAMBER FRONT PROFILE CORNER KIT | <table border="1"> <thead> <tr> <th>Code</th> <th>Description</th> <th>Qty</th> <th>UOM</th> </tr> </thead> <tbody> <tr> <td>VM2249A0</td> <td>COOKING CHAMBER FRONT CORNER</td> <td>1.000</td> <td>PC</td> </tr> </tbody> </table> | Code | Description | Qty | UOM | VM2249A0 | COOKING CHAMBER FRONT CORNER | 1.000 | PC | | | | | | | | |
| Code | Description | Qty | UOM | | | | | | | | | | | | | | | | | | |
| VM2249A0 | COOKING CHAMBER FRONT CORNER | 1.000 | PC | | | | | | | | | | | | | | | | | | |



| COMPONENT | | | SPARE PART | | | | | | | | | | |
|-----------|--|---|------------|--|---|------|-------------|-----|-----|----------|--|-------|----|
| Code | Description | Image | Code | Description | Kit components | | | | | | | | |
| VM2509A | BL SHOP.PRO BLIND LOCK VENTILATION |  | KVM2509A | BL SHOP.PRO BLIND LOCK VENTILATION KIT | <table border="1"> <thead> <tr> <th>Code</th> <th>Description</th> <th>Qty</th> <th>UOM</th> </tr> </thead> <tbody> <tr> <td>VM2509A1</td> <td>BL SHOP.PRO BLIND LOCK VENTILATION</td> <td>1.000</td> <td>PC</td> </tr> </tbody> </table> | Code | Description | Qty | UOM | VM2509A1 | BL SHOP.PRO BLIND LOCK VENTILATION | 1.000 | PC |
| Code | Description | Qty | UOM | | | | | | | | | | |
| VM2509A1 | BL SHOP.PRO BLIND LOCK VENTILATION | 1.000 | PC | | | | | | | | | | |
| VM2511A | SP FRONT PANEL HOLE PLATE COVER |  | KVM2511A | SP FRONT PANEL HOLE PLATE COVER 2PCS KIT | <table border="1"> <thead> <tr> <th>Code</th> <th>Description</th> <th>Qty</th> <th>UOM</th> </tr> </thead> <tbody> <tr> <td>VM2511A0</td> <td>SP FRONT PANEL HOLE PLATE COVER</td> <td>2.000</td> <td>PC</td> </tr> </tbody> </table> | Code | Description | Qty | UOM | VM2511A0 | SP FRONT PANEL HOLE PLATE COVER | 2.000 | PC |
| Code | Description | Qty | UOM | | | | | | | | | | |
| VM2511A0 | SP FRONT PANEL HOLE PLATE COVER | 2.000 | PC | | | | | | | | | | |



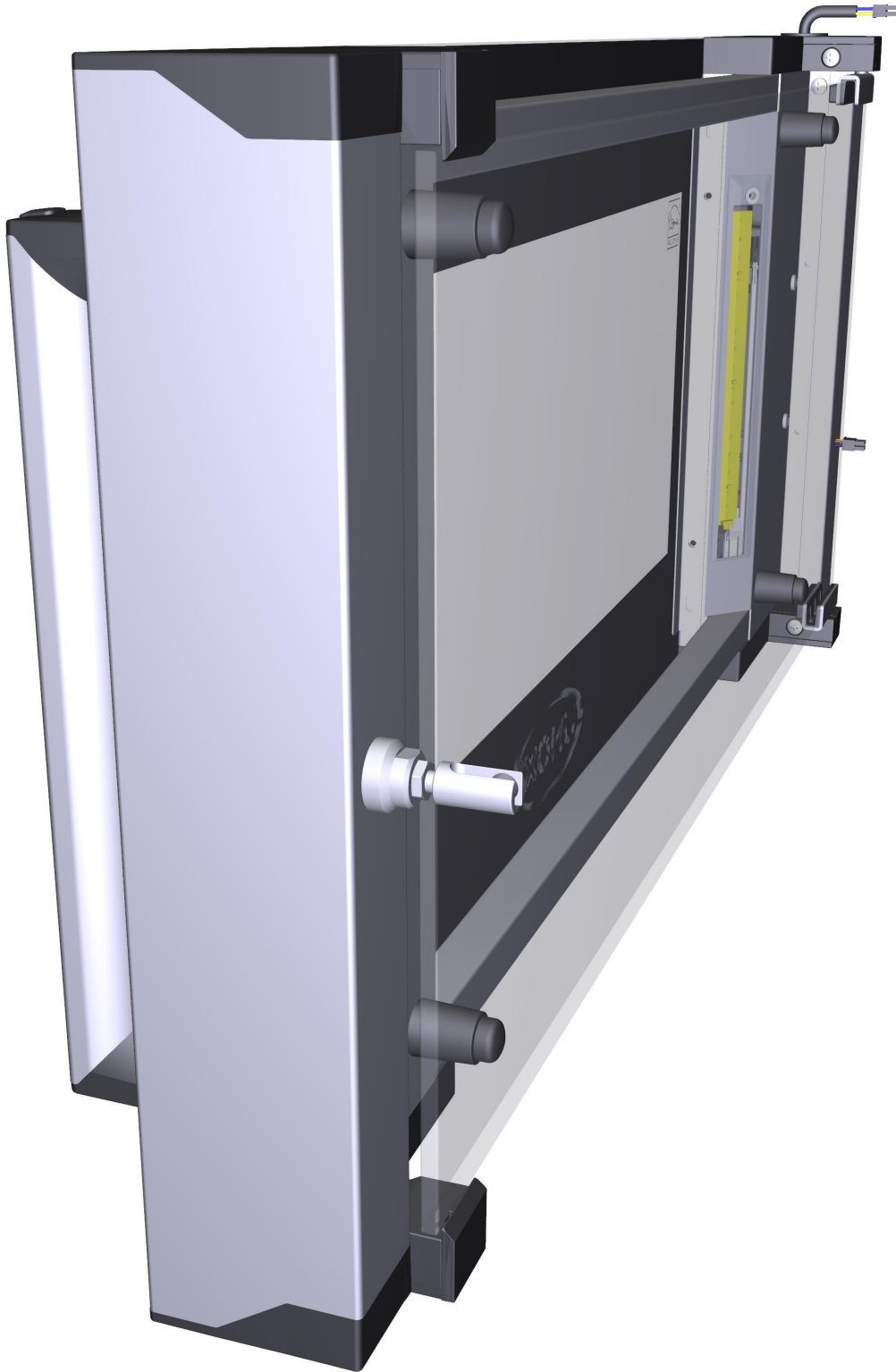

ASM3429B/0.D00 - Door - FRONT







ASM3429B/0.D00 - Door - REAR







| COMPONENT | | | SPARE PART | | | | | | | | | | | | | | | | | | |
|-----------|--|---|------------|--|---|------|-------------|-----|-----|----------|-----------------------------------|-------|----|----------|----------------------------------|-------|----|----------|-------------------------------|-------|----|
| Code | Description | Image | Code | Description | Kit components | | | | | | | | | | | | | | | | |
| 0B1293A | SP STE-ELE RIGHT DOOR LEFT EXT COLUMN |  | 0B1293A0 | SP STE-ELE RIGHT DOOR LEFT EXT COLUMN | | | | | | | | | | | | | | | | | |
| 0B1294A | SP STE-ELE RIGHT DOOR LEFT INT COLUMN |  | 0B1294A0 | SP STE-ELE RIGHT DOOR LEFT INT COLUMN | | | | | | | | | | | | | | | | | |
| 0B1295B | SP STE-ELE RIGHT DOOR RIGHT EXT COLUMN |  | 0B1295B0 | SP STE-ELE RIGHT DOOR RIGHT EXT COLUMN | | | | | | | | | | | | | | | | | |
| 0B1296B | SP STE-ELE RIGHT DOOR RIGHT INT COLUMN |  | 0B1296B0 | SP STE-ELE RIGHT DOOR RIGHT INT COLUMN | | | | | | | | | | | | | | | | | |
| LP1050A | BL SHOP.PRO L180 COMPLETE LED BA |  | KLP1050A | L180 COMPLETE LED LIGHT BAR KIT | <table border="1"> <thead> <tr> <th>Code</th> <th>Description</th> <th>Qty</th> <th>UOM</th> </tr> </thead> <tbody> <tr> <td>LP1050A0</td> <td>BL SHOP.PRO L180 COMPLETE LED BAR</td> <td>1.000</td> <td>PC</td> </tr> <tr> <td>VI1014A0</td> <td>STAINLESS STEEL WASHER 4.5X9X0.8</td> <td>1.000</td> <td>PC</td> </tr> <tr> <td>VI1220A1</td> <td>4,2x12 TCB SELF-TAPPING SCREW</td> <td>1.000</td> <td>PC</td> </tr> </tbody> </table> | Code | Description | Qty | UOM | LP1050A0 | BL SHOP.PRO L180 COMPLETE LED BAR | 1.000 | PC | VI1014A0 | STAINLESS STEEL WASHER 4.5X9X0.8 | 1.000 | PC | VI1220A1 | 4,2x12 TCB SELF-TAPPING SCREW | 1.000 | PC |
| Code | Description | Qty | UOM | | | | | | | | | | | | | | | | | | |
| LP1050A0 | BL SHOP.PRO L180 COMPLETE LED BAR | 1.000 | PC | | | | | | | | | | | | | | | | | | |
| VI1014A0 | STAINLESS STEEL WASHER 4.5X9X0.8 | 1.000 | PC | | | | | | | | | | | | | | | | | | |
| VI1220A1 | 4,2x12 TCB SELF-TAPPING SCREW | 1.000 | PC | | | | | | | | | | | | | | | | | | |





| COMPONENT | | | SPARE PART | | | | | | | | | | | | | | | | | | | | | | | | | | |
|-----------|--|---|------------|--|--|--|-------------|-----|-----|----------|--|-------|----|----------|------------------------------|-------|----|----------|--------------------------------|-------|----|----------|--------------------------------|-------|----|----------|-----------------------------|-------|----|
| Code | Description | Image | Code | Description | Kit components | | | | | | | | | | | | | | | | | | | | | | | | |
| TB3303A | SHOP.PRO STE-ELE FLAG DOOR HANDLE TUBE |  | KTB3303A | BL SP STE-ELE LATER DOOR HANDLE TUBE KIT | <table border="1"> <thead> <tr> <th>Code</th> <th>Description</th> <th>Qty</th> <th>UOM</th> </tr> </thead> <tbody> <tr> <td>TB3303A0</td> <td>SHOP.PRO STE-ELE FLAG DOOR HANDLE TUBE</td> <td>1.000</td> <td>PC</td> </tr> <tr> <td>VI1147A0</td> <td>5X25 STAINLESS STEEL SCREW</td> <td>4.000</td> <td>PC</td> </tr> <tr> <td>VM2456A0</td> <td>BAKERLUX SHOP.PRO HANDLE END</td> <td>1.000</td> <td>PC</td> </tr> <tr> <td>VM2489A0</td> <td>SP HANDLE END KIT + STYLUS KIT</td> <td>1.000</td> <td>PC</td> </tr> <tr> <td>VM2527A1</td> <td>EVEREO-S.Pro DISPLAY STYLUS</td> <td>1.000</td> <td>PC</td> </tr> </tbody> </table> | Code | Description | Qty | UOM | TB3303A0 | SHOP.PRO STE-ELE FLAG DOOR HANDLE TUBE | 1.000 | PC | VI1147A0 | 5X25 STAINLESS STEEL SCREW | 4.000 | PC | VM2456A0 | BAKERLUX SHOP.PRO HANDLE END | 1.000 | PC | VM2489A0 | SP HANDLE END KIT + STYLUS KIT | 1.000 | PC | VM2527A1 | EVEREO-S.Pro DISPLAY STYLUS | 1.000 | PC |
| | | | | | Code | Description | Qty | UOM | | | | | | | | | | | | | | | | | | | | | |
| | | | | | TB3303A0 | SHOP.PRO STE-ELE FLAG DOOR HANDLE TUBE | 1.000 | PC | | | | | | | | | | | | | | | | | | | | | |
| | | | | | VI1147A0 | 5X25 STAINLESS STEEL SCREW | 4.000 | PC | | | | | | | | | | | | | | | | | | | | | |
| | | | | | VM2456A0 | BAKERLUX SHOP.PRO HANDLE END | 1.000 | PC | | | | | | | | | | | | | | | | | | | | | |
| VM2489A0 | SP HANDLE END KIT + STYLUS KIT | 1.000 | PC | | | | | | | | | | | | | | | | | | | | | | | | | | |
| VM2527A1 | EVEREO-S.Pro DISPLAY STYLUS | 1.000 | PC | | | | | | | | | | | | | | | | | | | | | | | | | | |
| VM2456A | BAKERLUX SHOP.PRO HANDLE END |  | KVM2456A | 2 PCS BAKERLUX SHOP.PRO HANDLE END KIT | <table border="1"> <thead> <tr> <th>Code</th> <th>Description</th> <th>Qty</th> <th>UOM</th> </tr> </thead> <tbody> <tr> <td>VI1147A0</td> <td>5X25 STAINLESS STEEL SCREW</td> <td>4.000</td> <td>PC</td> </tr> <tr> <td>VM2456A0</td> <td>BAKERLUX SHOP.PRO HANDLE END</td> <td>1.000</td> <td>PC</td> </tr> <tr> <td>VM2489A0</td> <td>SP HANDLE END KIT + STYLUS KIT</td> <td>1.000</td> <td>PC</td> </tr> <tr> <td>VM2527A1</td> <td>EVEREO-S.Pro DISPLAY STYLUS</td> <td>1.000</td> <td>PC</td> </tr> </tbody> </table> | Code | Description | Qty | UOM | VI1147A0 | 5X25 STAINLESS STEEL SCREW | 4.000 | PC | VM2456A0 | BAKERLUX SHOP.PRO HANDLE END | 1.000 | PC | VM2489A0 | SP HANDLE END KIT + STYLUS KIT | 1.000 | PC | VM2527A1 | EVEREO-S.Pro DISPLAY STYLUS | 1.000 | PC | | | | |
| | | | | | Code | Description | Qty | UOM | | | | | | | | | | | | | | | | | | | | | |
| | | | | | VI1147A0 | 5X25 STAINLESS STEEL SCREW | 4.000 | PC | | | | | | | | | | | | | | | | | | | | | |
| | | | | | VM2456A0 | BAKERLUX SHOP.PRO HANDLE END | 1.000 | PC | | | | | | | | | | | | | | | | | | | | | |
| VM2489A0 | SP HANDLE END KIT + STYLUS KIT | 1.000 | PC | | | | | | | | | | | | | | | | | | | | | | | | | | |
| VM2527A1 | EVEREO-S.Pro DISPLAY STYLUS | 1.000 | PC | | | | | | | | | | | | | | | | | | | | | | | | | | |
| VM2527A | EVEREO-S.Pro DISPLAY STYLUS |  | KVM2527A | EVEREO-S.Pro TOUCH STYLUS 5 PCS KIT | <table border="1"> <thead> <tr> <th>Code</th> <th>Description</th> <th>Qty</th> <th>UOM</th> </tr> </thead> <tbody> <tr> <td>VM2527A1</td> <td>EVEREO-S.Pro DISPLAY STYLUS</td> <td>5.000</td> <td>PC</td> </tr> </tbody> </table> | Code | Description | Qty | UOM | VM2527A1 | EVEREO-S.Pro DISPLAY STYLUS | 5.000 | PC | | | | | | | | | | | | | | | | |
| Code | Description | Qty | UOM | | | | | | | | | | | | | | | | | | | | | | | | | | |
| VM2527A1 | EVEREO-S.Pro DISPLAY STYLUS | 5.000 | PC | | | | | | | | | | | | | | | | | | | | | | | | | | |
| VI1174A | VI1174A0 |  | VI1174A0 | VI1174A0 | | | | | | | | | | | | | | | | | | | | | | | | | |



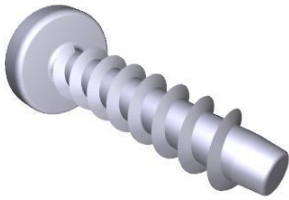
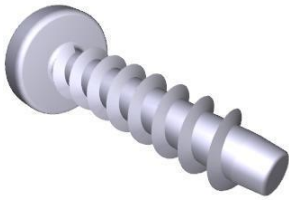

| COMPONENT | | | SPARE PART | | | | | | | | | | | | | | | | | | |
|-----------|--------------------------------------|---|------------|--|---|------|-------------|-----|-----|----------|--------------------------------------|-------|----|----------|--------------------------------------|-------|----|----------|--------------------------------------|-------|----|
| Code | Description | Image | Code | Description | Kit components | | | | | | | | | | | | | | | | |
| VM2468A | BL SP LEFT UPPER LATERAL DOOR CA |  | KVM2468A | BL SP LEFT UPPER LATERAL DOOR CAP KIT | <table border="1"> <thead> <tr> <th>Code</th> <th>Description</th> <th>Qty</th> <th>UOM</th> </tr> </thead> <tbody> <tr> <td>VM2468A0</td> <td>BL SP LEFT UPPER LATERAL DOOR CAP</td> <td>1.000</td> <td>PC</td> </tr> </tbody> </table> | Code | Description | Qty | UOM | VM2468A0 | BL SP LEFT UPPER LATERAL DOOR CAP | 1.000 | PC | | | | | | | | |
| Code | Description | Qty | UOM | | | | | | | | | | | | | | | | | | |
| VM2468A0 | BL SP LEFT UPPER LATERAL DOOR CAP | 1.000 | PC | | | | | | | | | | | | | | | | | | |
| VM2474A | BL SP INT GLASS HINGE UPPER LOCK PIN |  | KVM2474A | BL SP INT GLASS HINGE UPPER LOCK PIN KIT | <table border="1"> <thead> <tr> <th>Code</th> <th>Description</th> <th>Qty</th> <th>UOM</th> </tr> </thead> <tbody> <tr> <td>VM2474A0</td> <td>BL SP INT GLASS HINGE UPPER LOCK PIN</td> <td>1.000</td> <td>PC</td> </tr> </tbody> </table> | Code | Description | Qty | UOM | VM2474A0 | BL SP INT GLASS HINGE UPPER LOCK PIN | 1.000 | PC | | | | | | | | |
| Code | Description | Qty | UOM | | | | | | | | | | | | | | | | | | |
| VM2474A0 | BL SP INT GLASS HINGE UPPER LOCK PIN | 1.000 | PC | | | | | | | | | | | | | | | | | | |
| ML1005A | DE5 DF0.6 H18 COMPRESSION SPRING |  | KVM2470A | BL SHOP.PRO INTERNAL GLASS LOCK 2PCS KIT | <table border="1"> <thead> <tr> <th>Code</th> <th>Description</th> <th>Qty</th> <th>UOM</th> </tr> </thead> <tbody> <tr> <td>ML1005A0</td> <td>DE5 DF0.6 H18 COMPRESSION SPRING</td> <td>2.000</td> <td>PC</td> </tr> <tr> <td>VM2470A0</td> <td>SLIDE TO FIX INTERNAL GLASS SHOP.PRO</td> <td>2.000</td> <td>PC</td> </tr> <tr> <td>VM2504A0</td> <td>DOWEL TO GUIDE SLIDE SPRING SHOP.PRO</td> <td>2.000</td> <td>PC</td> </tr> </tbody> </table> | Code | Description | Qty | UOM | ML1005A0 | DE5 DF0.6 H18 COMPRESSION SPRING | 2.000 | PC | VM2470A0 | SLIDE TO FIX INTERNAL GLASS SHOP.PRO | 2.000 | PC | VM2504A0 | DOWEL TO GUIDE SLIDE SPRING SHOP.PRO | 2.000 | PC |
| Code | Description | Qty | UOM | | | | | | | | | | | | | | | | | | |
| ML1005A0 | DE5 DF0.6 H18 COMPRESSION SPRING | 2.000 | PC | | | | | | | | | | | | | | | | | | |
| VM2470A0 | SLIDE TO FIX INTERNAL GLASS SHOP.PRO | 2.000 | PC | | | | | | | | | | | | | | | | | | |
| VM2504A0 | DOWEL TO GUIDE SLIDE SPRING SHOP.PRO | 2.000 | PC | | | | | | | | | | | | | | | | | | |
| VM2470A | SLIDE TO FIX INTERNAL GLASS SHOP.PRO |  | KVM2470A | BL SHOP.PRO INTERNAL GLASS LOCK 2PCS KIT | <table border="1"> <thead> <tr> <th>Code</th> <th>Description</th> <th>Qty</th> <th>UOM</th> </tr> </thead> <tbody> <tr> <td>ML1005A0</td> <td>DE5 DF0.6 H18 COMPRESSION SPRING</td> <td>2.000</td> <td>PC</td> </tr> <tr> <td>VM2470A0</td> <td>SLIDE TO FIX INTERNAL GLASS SHOP.PRO</td> <td>2.000</td> <td>PC</td> </tr> <tr> <td>VM2504A0</td> <td>DOWEL TO GUIDE SLIDE SPRING SHOP.PRO</td> <td>2.000</td> <td>PC</td> </tr> </tbody> </table> | Code | Description | Qty | UOM | ML1005A0 | DE5 DF0.6 H18 COMPRESSION SPRING | 2.000 | PC | VM2470A0 | SLIDE TO FIX INTERNAL GLASS SHOP.PRO | 2.000 | PC | VM2504A0 | DOWEL TO GUIDE SLIDE SPRING SHOP.PRO | 2.000 | PC |
| Code | Description | Qty | UOM | | | | | | | | | | | | | | | | | | |
| ML1005A0 | DE5 DF0.6 H18 COMPRESSION SPRING | 2.000 | PC | | | | | | | | | | | | | | | | | | |
| VM2470A0 | SLIDE TO FIX INTERNAL GLASS SHOP.PRO | 2.000 | PC | | | | | | | | | | | | | | | | | | |
| VM2504A0 | DOWEL TO GUIDE SLIDE SPRING SHOP.PRO | 2.000 | PC | | | | | | | | | | | | | | | | | | |



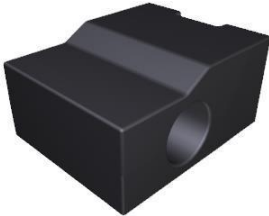

| COMPONENT | | | SPARE PART | | | | | | | | | | | | | | | | | | |
|-----------|---|---|------------|--|--|------|-------------|-----|-----|----------|---|-------|----|----------|--|-------|----|----------|--|-------|----|
| Code | Description | Image | Code | Description | Kit components | | | | | | | | | | | | | | | | |
| VM2472A | BL SP UPPER CLAMP INT LOCK GLASS SLIDER |  | KVM2471A | BL SP INTERNAL GLASS LOCK HOLDER KIT | <table border="1"> <thead> <tr> <th>Code</th> <th>Description</th> <th>Qty</th> <th>UOM</th> </tr> </thead> <tbody> <tr> <td>V11998A0</td> <td>ZINC PLATED SCREW 5X30 TCB</td> <td>2.000</td> <td>PC</td> </tr> <tr> <td>VM2471A0</td> <td>BL SP LOWER CLAMP INT LOCK GLASS SLIDER</td> <td>1.000</td> <td>PC</td> </tr> <tr> <td>VM2472A0</td> <td>BL SP UPPER CLAMP INT LOCK GLASS SLIDER</td> <td>1.000</td> <td>PC</td> </tr> </tbody> </table> | Code | Description | Qty | UOM | V11998A0 | ZINC PLATED SCREW 5X30 TCB | 2.000 | PC | VM2471A0 | BL SP LOWER CLAMP INT LOCK GLASS SLIDER | 1.000 | PC | VM2472A0 | BL SP UPPER CLAMP INT LOCK GLASS SLIDER | 1.000 | PC |
| Code | Description | Qty | UOM | | | | | | | | | | | | | | | | | | |
| V11998A0 | ZINC PLATED SCREW 5X30 TCB | 2.000 | PC | | | | | | | | | | | | | | | | | | |
| VM2471A0 | BL SP LOWER CLAMP INT LOCK GLASS SLIDER | 1.000 | PC | | | | | | | | | | | | | | | | | | |
| VM2472A0 | BL SP UPPER CLAMP INT LOCK GLASS SLIDER | 1.000 | PC | | | | | | | | | | | | | | | | | | |
| VM2504A | DOWEL TO GUIDE SLIDE SPRING SHOP.PRO |  | KVM2470A | BL SHOP.PRO INTERNAL GLASS LOCK 2PCS KIT | <table border="1"> <thead> <tr> <th>Code</th> <th>Description</th> <th>Qty</th> <th>UOM</th> </tr> </thead> <tbody> <tr> <td>ML1005A0</td> <td>DES DF0.6 H18 COMPRESSIO N SPRING</td> <td>2.000</td> <td>PC</td> </tr> <tr> <td>VM2470A0</td> <td>SLIDE TO FIX INTERNAL GLASS SHOP.PRO</td> <td>2.000</td> <td>PC</td> </tr> <tr> <td>VM2504A0</td> <td>DOWEL TO GUIDE SLIDE SPRING SHOP.PRO</td> <td>2.000</td> <td>PC</td> </tr> </tbody> </table> | Code | Description | Qty | UOM | ML1005A0 | DES DF0.6 H18 COMPRESSIO N SPRING | 2.000 | PC | VM2470A0 | SLIDE TO FIX INTERNAL GLASS SHOP.PRO | 2.000 | PC | VM2504A0 | DOWEL TO GUIDE SLIDE SPRING SHOP.PRO | 2.000 | PC |
| Code | Description | Qty | UOM | | | | | | | | | | | | | | | | | | |
| ML1005A0 | DES DF0.6 H18 COMPRESSIO N SPRING | 2.000 | PC | | | | | | | | | | | | | | | | | | |
| VM2470A0 | SLIDE TO FIX INTERNAL GLASS SHOP.PRO | 2.000 | PC | | | | | | | | | | | | | | | | | | |
| VM2504A0 | DOWEL TO GUIDE SLIDE SPRING SHOP.PRO | 2.000 | PC | | | | | | | | | | | | | | | | | | |
| VM2467A | SP SIDE-OPENING DOOR RIGHT UPPER CAP KIT |  | KVM2467A | BL SP RIGHT UPPER LATERAL DOOR CAP KIT | <table border="1"> <thead> <tr> <th>Code</th> <th>Description</th> <th>Qty</th> <th>UOM</th> </tr> </thead> <tbody> <tr> <td>VM2467A0</td> <td>SP SIDE-OPENIN G DOOR RIGHT UPPER CAP KIT</td> <td>1.000</td> <td>PC</td> </tr> </tbody> </table> | Code | Description | Qty | UOM | VM2467A0 | SP SIDE-OPENIN G DOOR RIGHT UPPER CAP KIT | 1.000 | PC | | | | | | | | |
| Code | Description | Qty | UOM | | | | | | | | | | | | | | | | | | |
| VM2467A0 | SP SIDE-OPENIN G DOOR RIGHT UPPER CAP KIT | 1.000 | PC | | | | | | | | | | | | | | | | | | |
| TB1563A | DOOR LATERAL BEAM SP800 |  | TB1563A0 | DOOR LATERAL BEAM SP800 | | | | | | | | | | | | | | | | | |

| COMPONENT | | | SPARE PART | | | | | | | | | | | | | | | | | | |
|-----------|--------------------------------------|---|------------|--|---|------|-------------|-----|-----|----------|--------------------------------------|-------|----|----------|--------------------------------------|-------|----|----------|--------------------------------------|-------|----|
| Code | Description | Image | Code | Description | Kit components | | | | | | | | | | | | | | | | |
| VI1174A | VI1174A0 |  | VI1174A0 | VI1174A0 | | | | | | | | | | | | | | | | | |
| VI1174A | VI1174A0 |  | VI1174A0 | VI1174A0 | | | | | | | | | | | | | | | | | |
| VM2466A | BL SP LEFT LOWER LATERAL DOOR CA |  | KVM2466A | BL SP LEFT LOWER LATERAL DOOR CAP KIT | <table border="1"> <thead> <tr> <th>Code</th> <th>Description</th> <th>Qty</th> <th>UOM</th> </tr> </thead> <tbody> <tr> <td>VM2466A0</td> <td>BL SP LEFT LOWER LATERAL DOOR CAP</td> <td>1.000</td> <td>PC</td> </tr> </tbody> </table> | Code | Description | Qty | UOM | VM2466A0 | BL SP LEFT LOWER LATERAL DOOR CAP | 1.000 | PC | | | | | | | | |
| Code | Description | Qty | UOM | | | | | | | | | | | | | | | | | | |
| VM2466A0 | BL SP LEFT LOWER LATERAL DOOR CAP | 1.000 | PC | | | | | | | | | | | | | | | | | | |
| VM2473A | BL SP INT GLASS HINGE LOWER LOCK PIN |  | KVM2473A | BL SP INT GLASS HINGE LOWER LOCK PIN KIT | <table border="1"> <thead> <tr> <th>Code</th> <th>Description</th> <th>Qty</th> <th>UOM</th> </tr> </thead> <tbody> <tr> <td>VM2473A0</td> <td>BL SP INT GLASS HINGE LOWER LOCK PIN</td> <td>1.000</td> <td>PC</td> </tr> </tbody> </table> | Code | Description | Qty | UOM | VM2473A0 | BL SP INT GLASS HINGE LOWER LOCK PIN | 1.000 | PC | | | | | | | | |
| Code | Description | Qty | UOM | | | | | | | | | | | | | | | | | | |
| VM2473A0 | BL SP INT GLASS HINGE LOWER LOCK PIN | 1.000 | PC | | | | | | | | | | | | | | | | | | |
| ML1005A | DE5 DF0.6 H18 COMPRESSION SPRING |  | KVM2470A | BL SHOP.PRO INTERNAL GLASS LOCK 2PCS KIT | <table border="1"> <thead> <tr> <th>Code</th> <th>Description</th> <th>Qty</th> <th>UOM</th> </tr> </thead> <tbody> <tr> <td>ML1005A0</td> <td>DE5 DF0.6 H18 COMPRESSION SPRING</td> <td>2.000</td> <td>PC</td> </tr> <tr> <td>VM2470A0</td> <td>SLIDE TO FIX INTERNAL GLASS SHOP.PRO</td> <td>2.000</td> <td>PC</td> </tr> <tr> <td>VM2504A0</td> <td>DOWEL TO GUIDE SLIDE SPRING SHOP.PRO</td> <td>2.000</td> <td>PC</td> </tr> </tbody> </table> | Code | Description | Qty | UOM | ML1005A0 | DE5 DF0.6 H18 COMPRESSION SPRING | 2.000 | PC | VM2470A0 | SLIDE TO FIX INTERNAL GLASS SHOP.PRO | 2.000 | PC | VM2504A0 | DOWEL TO GUIDE SLIDE SPRING SHOP.PRO | 2.000 | PC |
| Code | Description | Qty | UOM | | | | | | | | | | | | | | | | | | |
| ML1005A0 | DE5 DF0.6 H18 COMPRESSION SPRING | 2.000 | PC | | | | | | | | | | | | | | | | | | |
| VM2470A0 | SLIDE TO FIX INTERNAL GLASS SHOP.PRO | 2.000 | PC | | | | | | | | | | | | | | | | | | |
| VM2504A0 | DOWEL TO GUIDE SLIDE SPRING SHOP.PRO | 2.000 | PC | | | | | | | | | | | | | | | | | | |

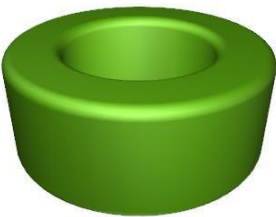
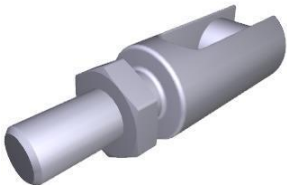

| COMPONENT | | | SPARE PART | | | | | | | | | | | | | | | | | | |
|-----------|---|---|------------|--|--|------|-------------|-----|-----|----------|---|-------|----|----------|--|-------|----|----------|--|-------|----|
| Code | Description | Image | Code | Description | Kit components | | | | | | | | | | | | | | | | |
| VM2470A | SLIDE TO FIX INTERNAL GLASS SHOP.PRO |  | KVM2470A | BL SHOP.PRO INTERNAL GLASS LOCK 2PCS KIT | <table border="1"> <thead> <tr> <th>Code</th> <th>Description</th> <th>Qty</th> <th>UOM</th> </tr> </thead> <tbody> <tr> <td>ML1005A0</td> <td>DES DF0.6 H18 COMPRESSIO N SPRING</td> <td>2.000</td> <td>PC</td> </tr> <tr> <td>VM2470A0</td> <td>SLIDE TO FIX INTERNAL GLASS SHOP.PRO</td> <td>2.000</td> <td>PC</td> </tr> <tr> <td>VM2504A0</td> <td>DOWEL TO GUIDE SLIDE SPRING SHOP.PRO</td> <td>2.000</td> <td>PC</td> </tr> </tbody> </table> | Code | Description | Qty | UOM | ML1005A0 | DES DF0.6 H18 COMPRESSIO N SPRING | 2.000 | PC | VM2470A0 | SLIDE TO FIX INTERNAL GLASS SHOP.PRO | 2.000 | PC | VM2504A0 | DOWEL TO GUIDE SLIDE SPRING SHOP.PRO | 2.000 | PC |
| Code | Description | Qty | UOM | | | | | | | | | | | | | | | | | | |
| ML1005A0 | DES DF0.6 H18 COMPRESSIO N SPRING | 2.000 | PC | | | | | | | | | | | | | | | | | | |
| VM2470A0 | SLIDE TO FIX INTERNAL GLASS SHOP.PRO | 2.000 | PC | | | | | | | | | | | | | | | | | | |
| VM2504A0 | DOWEL TO GUIDE SLIDE SPRING SHOP.PRO | 2.000 | PC | | | | | | | | | | | | | | | | | | |
| VM2471A | BL SP LOWER CLAMP INT LOCK GLASS SLIDER |  | KVM2471A | BL SP INTERNAL GLASS LOCK HOLDER KIT | <table border="1"> <thead> <tr> <th>Code</th> <th>Description</th> <th>Qty</th> <th>UOM</th> </tr> </thead> <tbody> <tr> <td>VH1998A0</td> <td>ZINC PLATED SCREW 5X30 TCB</td> <td>2.000</td> <td>PC</td> </tr> <tr> <td>VM2471A0</td> <td>BL SP LOWER CLAMP INT LOCK GLASS SLIDER</td> <td>1.000</td> <td>PC</td> </tr> <tr> <td>VM2472A0</td> <td>BL SP UPPER CLAMP INT LOCK GLASS SLIDER</td> <td>1.000</td> <td>PC</td> </tr> </tbody> </table> | Code | Description | Qty | UOM | VH1998A0 | ZINC PLATED SCREW 5X30 TCB | 2.000 | PC | VM2471A0 | BL SP LOWER CLAMP INT LOCK GLASS SLIDER | 1.000 | PC | VM2472A0 | BL SP UPPER CLAMP INT LOCK GLASS SLIDER | 1.000 | PC |
| Code | Description | Qty | UOM | | | | | | | | | | | | | | | | | | |
| VH1998A0 | ZINC PLATED SCREW 5X30 TCB | 2.000 | PC | | | | | | | | | | | | | | | | | | |
| VM2471A0 | BL SP LOWER CLAMP INT LOCK GLASS SLIDER | 1.000 | PC | | | | | | | | | | | | | | | | | | |
| VM2472A0 | BL SP UPPER CLAMP INT LOCK GLASS SLIDER | 1.000 | PC | | | | | | | | | | | | | | | | | | |
| VM2504A | DOWEL TO GUIDE SLIDE SPRING SHOP.PRO |  | KVM2470A | BL SHOP.PRO INTERNAL GLASS LOCK 2PCS KIT | <table border="1"> <thead> <tr> <th>Code</th> <th>Description</th> <th>Qty</th> <th>UOM</th> </tr> </thead> <tbody> <tr> <td>ML1005A0</td> <td>DES DF0.6 H18 COMPRESSIO N SPRING</td> <td>2.000</td> <td>PC</td> </tr> <tr> <td>VM2470A0</td> <td>SLIDE TO FIX INTERNAL GLASS SHOP.PRO</td> <td>2.000</td> <td>PC</td> </tr> <tr> <td>VM2504A0</td> <td>DOWEL TO GUIDE SLIDE SPRING SHOP.PRO</td> <td>2.000</td> <td>PC</td> </tr> </tbody> </table> | Code | Description | Qty | UOM | ML1005A0 | DES DF0.6 H18 COMPRESSIO N SPRING | 2.000 | PC | VM2470A0 | SLIDE TO FIX INTERNAL GLASS SHOP.PRO | 2.000 | PC | VM2504A0 | DOWEL TO GUIDE SLIDE SPRING SHOP.PRO | 2.000 | PC |
| Code | Description | Qty | UOM | | | | | | | | | | | | | | | | | | |
| ML1005A0 | DES DF0.6 H18 COMPRESSIO N SPRING | 2.000 | PC | | | | | | | | | | | | | | | | | | |
| VM2470A0 | SLIDE TO FIX INTERNAL GLASS SHOP.PRO | 2.000 | PC | | | | | | | | | | | | | | | | | | |
| VM2504A0 | DOWEL TO GUIDE SLIDE SPRING SHOP.PRO | 2.000 | PC | | | | | | | | | | | | | | | | | | |
| VM2465A | SP SIDE-OPENING DOOR RIGHT LOWER CAP KIT |  | KVM2465A | BL SP RIGHT LOWER LATERAL DOOR CAP KIT | <table border="1"> <thead> <tr> <th>Code</th> <th>Description</th> <th>Qty</th> <th>UOM</th> </tr> </thead> <tbody> <tr> <td>VM2465A0</td> <td>SP SIDE-OPENIN G DOOR RIGHT LOWER CAP KIT</td> <td>1.000</td> <td>PC</td> </tr> </tbody> </table> | Code | Description | Qty | UOM | VM2465A0 | SP SIDE-OPENIN G DOOR RIGHT LOWER CAP KIT | 1.000 | PC | | | | | | | | |
| Code | Description | Qty | UOM | | | | | | | | | | | | | | | | | | |
| VM2465A0 | SP SIDE-OPENIN G DOOR RIGHT LOWER CAP KIT | 1.000 | PC | | | | | | | | | | | | | | | | | | |

| COMPONENT | | | SPARE PART | | | | | | | | | | | | | | |
|-----------|--------------------------------|---|------------|--|---|------|-------------|-----|-----|----------|--------------------------------|--------|----|----------|--------------------------------|-------|----|
| Code | Description | Image | Code | Description | Kit components | | | | | | | | | | | | |
| TB1563A | DOOR LATERAL BEAM SP800 |  | TB1563A0 | DOOR LATERAL BEAM SP800 | | | | | | | | | | | | | |
| VI1174A | VI1174A0 |  | VI1174A0 | VI1174A0 | | | | | | | | | | | | | |
| VM1630A | INTERNAL GLASS PUSHING CAP |  | KVM1630A | CAP FOR INTERNAL GLASS 10 PCS KIT | <table border="1"> <thead> <tr> <th>Code</th> <th>Description</th> <th>Qty</th> <th>UOM</th> </tr> </thead> <tbody> <tr> <td>VM1630A1</td> <td>INTERNAL GLASS PUSHING CAP</td> <td>10.000</td> <td>PC</td> </tr> </tbody> </table> | Code | Description | Qty | UOM | VM1630A1 | INTERNAL GLASS PUSHING CAP | 10.000 | PC | | | | |
| Code | Description | Qty | UOM | | | | | | | | | | | | | | |
| VM1630A1 | INTERNAL GLASS PUSHING CAP | 10.000 | PC | | | | | | | | | | | | | | |
| VM2479A | BL SP GLASS H6 PUSHING BRACKET |  | KVM2479A | BL SHOP.PRO H6 GLASS SUPPORT 6 PCS KIT | <table border="1"> <thead> <tr> <th>Code</th> <th>Description</th> <th>Qty</th> <th>UOM</th> </tr> </thead> <tbody> <tr> <td>VM1630A1</td> <td>INTERNAL GLASS PUSHING CAP</td> <td>6.000</td> <td>PC</td> </tr> <tr> <td>VM2479A0</td> <td>BL SP GLASS H6 PUSHING BRACKET</td> <td>6.000</td> <td>PC</td> </tr> </tbody> </table> | Code | Description | Qty | UOM | VM1630A1 | INTERNAL GLASS PUSHING CAP | 6.000 | PC | VM2479A0 | BL SP GLASS H6 PUSHING BRACKET | 6.000 | PC |
| Code | Description | Qty | UOM | | | | | | | | | | | | | | |
| VM1630A1 | INTERNAL GLASS PUSHING CAP | 6.000 | PC | | | | | | | | | | | | | | |
| VM2479A0 | BL SP GLASS H6 PUSHING BRACKET | 6.000 | PC | | | | | | | | | | | | | | |
| CE1095A | 4 POLES MICROFIT 2 M BUS CABLE |  | KCE1095A | 4POLES 2M BUS CABLE KIT POWER-CONTROL | <table border="1"> <thead> <tr> <th>Code</th> <th>Description</th> <th>Qty</th> <th>UOM</th> </tr> </thead> <tbody> <tr> <td>CE1095A0</td> <td>4 POLES MICROFIT 2 M BUS CABLE</td> <td>1.000</td> <td>PC</td> </tr> </tbody> </table> | Code | Description | Qty | UOM | CE1095A0 | 4 POLES MICROFIT 2 M BUS CABLE | 1.000 | PC | | | | |
| Code | Description | Qty | UOM | | | | | | | | | | | | | | |
| CE1095A0 | 4 POLES MICROFIT 2 M BUS CABLE | 1.000 | PC | | | | | | | | | | | | | | |

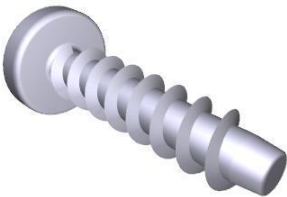
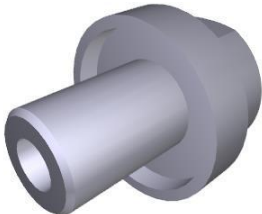
| COMPONENT | | | SPARE PART | | | | | | | | | | | | | | | | | | | | | | | | | | |
|-----------|--|---|------------|--|---|------|-------------|-----|-----|-----------|-------------------------------------|-------|----|----------|--|-------|----|----------|---------------------------|-------|----|----------|--|-------|----|----------|-----------------------------|-------|----|
| Code | Description | Image | Code | Description | Kit components | | | | | | | | | | | | | | | | | | | | | | | | |
| CE1285A | EMI ROUND FERRITE MOD.2643801502 |  | KCE1285A | ROUND FERRITE ELECTROMAGN PROT. 2PCS KIT | <table border="1"> <thead> <tr> <th>Code</th> <th>Description</th> <th>Qty</th> <th>UOM</th> </tr> </thead> <tbody> <tr> <td>CE1285A0</td> <td>EMI ROUND FERRITE MOD.2643801502</td> <td>2.000</td> <td>PC</td> </tr> </tbody> </table> | Code | Description | Qty | UOM | CE1285A0 | EMI ROUND FERRITE MOD.2643801502 | 2.000 | PC | | | | | | | | | | | | | | | | |
| Code | Description | Qty | UOM | | | | | | | | | | | | | | | | | | | | | | | | | | |
| CE1285A0 | EMI ROUND FERRITE MOD.2643801502 | 2.000 | PC | | | | | | | | | | | | | | | | | | | | | | | | | | |
| CR1040A | DOOR LATCH FOR EL.MECH. LOCKING SYSTEM |  | KCR1040A | LM MATIC DOOR LOCKING PIN KIT | <table border="1"> <thead> <tr> <th>Code</th> <th>Description</th> <th>Qty</th> <th>UOM</th> </tr> </thead> <tbody> <tr> <td>0H10283A0</td> <td></td> <td>1.000</td> <td>PC</td> </tr> <tr> <td>CR1040A0</td> <td>DOOR LATCH FOR EL.MECH. LOCKING SYSTEM</td> <td>1.000</td> <td>PC</td> </tr> </tbody> </table> | Code | Description | Qty | UOM | 0H10283A0 | | 1.000 | PC | CR1040A0 | DOOR LATCH FOR EL.MECH. LOCKING SYSTEM | 1.000 | PC | | | | | | | | | | | | |
| Code | Description | Qty | UOM | | | | | | | | | | | | | | | | | | | | | | | | | | |
| 0H10283A0 | | 1.000 | PC | | | | | | | | | | | | | | | | | | | | | | | | | | |
| CR1040A0 | DOOR LATCH FOR EL.MECH. LOCKING SYSTEM | 1.000 | PC | | | | | | | | | | | | | | | | | | | | | | | | | | |
| PE1445A | SHOP.Pro MASTER CAPACITIVE CONTROL PANEL |  | KPE1445A | SP MASTER CAPACITIVE CONTROL PANEL KI | <table border="1"> <thead> <tr> <th>Code</th> <th>Description</th> <th>Qty</th> <th>UOM</th> </tr> </thead> <tbody> <tr> <td>CE2112A0</td> <td></td> <td>1.000</td> <td>PC</td> </tr> <tr> <td>PE1445A0</td> <td>SHOP.Pro MASTER CAPACITIVE CONTROL PANEL</td> <td>1.000</td> <td>PC</td> </tr> <tr> <td>VI1930A1</td> <td>5x20 ST. STEEL CHIP SCREW</td> <td>2.000</td> <td>PC</td> </tr> <tr> <td>VM1447A0</td> <td></td> <td>1.000</td> <td>PC</td> </tr> <tr> <td>VM2527A1</td> <td>EVEREO-S.Pro DISPLAY STYLUS</td> <td>1.000</td> <td>PC</td> </tr> </tbody> </table> | Code | Description | Qty | UOM | CE2112A0 | | 1.000 | PC | PE1445A0 | SHOP.Pro MASTER CAPACITIVE CONTROL PANEL | 1.000 | PC | VI1930A1 | 5x20 ST. STEEL CHIP SCREW | 2.000 | PC | VM1447A0 | | 1.000 | PC | VM2527A1 | EVEREO-S.Pro DISPLAY STYLUS | 1.000 | PC |
| Code | Description | Qty | UOM | | | | | | | | | | | | | | | | | | | | | | | | | | |
| CE2112A0 | | 1.000 | PC | | | | | | | | | | | | | | | | | | | | | | | | | | |
| PE1445A0 | SHOP.Pro MASTER CAPACITIVE CONTROL PANEL | 1.000 | PC | | | | | | | | | | | | | | | | | | | | | | | | | | |
| VI1930A1 | 5x20 ST. STEEL CHIP SCREW | 2.000 | PC | | | | | | | | | | | | | | | | | | | | | | | | | | |
| VM1447A0 | | 1.000 | PC | | | | | | | | | | | | | | | | | | | | | | | | | | |
| VM2527A1 | EVEREO-S.Pro DISPLAY STYLUS | 1.000 | PC | | | | | | | | | | | | | | | | | | | | | | | | | | |
| VI1174A | VI1174A0 |  | VI1174A0 | VI1174A0 | | | | | | | | | | | | | | | | | | | | | | | | | |
| VM1209A | SHOP.PRO LOCK PIN WASHER |  | KVM1209A | BAKERLUX SHOP.PRO PIN BUSHING LOCK KIT | <table border="1"> <thead> <tr> <th>Code</th> <th>Description</th> <th>Qty</th> <th>UOM</th> </tr> </thead> <tbody> <tr> <td>VM1209A0</td> <td>SHOP.PRO LOCK PIN WASHER</td> <td>1.000</td> <td>PC</td> </tr> </tbody> </table> | Code | Description | Qty | UOM | VM1209A0 | SHOP.PRO LOCK PIN WASHER | 1.000 | PC | | | | | | | | | | | | | | | | |
| Code | Description | Qty | UOM | | | | | | | | | | | | | | | | | | | | | | | | | | |
| VM1209A0 | SHOP.PRO LOCK PIN WASHER | 1.000 | PC | | | | | | | | | | | | | | | | | | | | | | | | | | |



| COMPONENT | | | SPARE PART | | | | | | | | | | | | | | | | | | | | | | | | | | | | | | | | | | | | | | | | | | | | | | | |
|-----------|---|---|------------|-------------------------|--|------|-------------|------------------------------|-------|----------|-----------------|---|-------|----|----------|--------------------------------|-------|----|----------|-------------|-------|----|----------|--------------------------|-------|----|----------|-----------------------------------|-------|----|----------|-------------------------|-------|----|----------|-----------------------------------|-------|----|----------|-----------------------------------|-------|----|----------|-----------------|-------|----|----------|--------------------------------|-------|----|
| Code | Description | Image | Code | Description | Kit components | | | | | | | | | | | | | | | | | | | | | | | | | | | | | | | | | | | | | | | | | | | | | |
| VM2274A | GROOVED BUSHING |  | KVM2274A | GROOVED PIN BUSHING KIT | <table border="1"> <thead> <tr> <th>Code</th> <th>Description</th> <th>Qty</th> <th>UOM</th> </tr> </thead> <tbody> <tr> <td>VM2274A0</td> <td>GROOVED BUSHING</td> <td>1.000</td> <td>PC</td> </tr> </tbody> </table> | Code | Description | Qty | UOM | VM2274A0 | GROOVED BUSHING | 1.000 | PC | | | | | | | | | | | | | | | | | | | | | | | | | | | | | | | | | | | | | |
| | | | Code | Description | Qty | UOM | | | | | | | | | | | | | | | | | | | | | | | | | | | | | | | | | | | | | | | | | | | | |
| VM2274A0 | GROOVED BUSHING | 1.000 | PC | | | | | | | | | | | | | | | | | | | | | | | | | | | | | | | | | | | | | | | | | | | | | | | |
| K0B1126AR | BAKERTOP MM RIGHT DOOR LOWER BEAM KIT | <table border="1"> <thead> <tr> <th>Code</th> <th>Description</th> <th>Qty</th> <th>UOM</th> </tr> </thead> <tbody> <tr> <td>0B1126A1</td> <td>860mm DOOR LOWER FRAME SHAPE</td> <td>1.000</td> <td>PC</td> </tr> <tr> <td>RC1200A0</td> <td>ED=4 WIRE D=0.5 H24 COMPRESSIO N SPRING</td> <td>2.000</td> <td>PC</td> </tr> <tr> <td>VI1220A1</td> <td>4,2x12 TCB SELF-TAPPIN G SCREW</td> <td>1.000</td> <td>PC</td> </tr> <tr> <td>VI1996A0</td> <td>M5x35 SCREW</td> <td>7.000</td> <td>PC</td> </tr> <tr> <td>VM1794A0</td> <td>250x4.8 PA66 BLACK CLAMP</td> <td>2.000</td> <td>PC</td> </tr> <tr> <td>VM2259A1</td> <td>6 SERIES DOOR LOWER LEFT CAP</td> <td>1.000</td> <td>PC</td> </tr> <tr> <td>VM2261A1</td> <td>MM DOOR LOWER RIGHT CAP</td> <td>1.000</td> <td>PC</td> </tr> <tr> <td>VM2267A1</td> <td>INNER GLASS LOCKING SYSTEM SLIDER</td> <td>1.000</td> <td>PC</td> </tr> <tr> <td>VM2269A0</td> <td>INTERNAL GLASS LOCKING SYSTEM CAP</td> <td>1.000</td> <td>PC</td> </tr> <tr> <td>VM2274A0</td> <td>GROOVED BUSHING</td> <td>1.000</td> <td>PC</td> </tr> <tr> <td>VM2305A0</td> <td>MM SERIES DOOR CAP FIXING PAWL</td> <td>7.000</td> <td>PC</td> </tr> </tbody> </table> | Code | Description | Qty | UOM | 0B1126A1 | 860mm DOOR LOWER FRAME SHAPE | 1.000 | PC | RC1200A0 | ED=4 WIRE D=0.5 H24 COMPRESSIO N SPRING | 2.000 | PC | VI1220A1 | 4,2x12 TCB SELF-TAPPIN G SCREW | 1.000 | PC | VI1996A0 | M5x35 SCREW | 7.000 | PC | VM1794A0 | 250x4.8 PA66 BLACK CLAMP | 2.000 | PC | VM2259A1 | 6 SERIES DOOR LOWER LEFT CAP | 1.000 | PC | VM2261A1 | MM DOOR LOWER RIGHT CAP | 1.000 | PC | VM2267A1 | INNER GLASS LOCKING SYSTEM SLIDER | 1.000 | PC | VM2269A0 | INTERNAL GLASS LOCKING SYSTEM CAP | 1.000 | PC | VM2274A0 | GROOVED BUSHING | 1.000 | PC | VM2305A0 | MM SERIES DOOR CAP FIXING PAWL | 7.000 | PC |
| Code | Description | Qty | UOM | | | | | | | | | | | | | | | | | | | | | | | | | | | | | | | | | | | | | | | | | | | | | | | |
| 0B1126A1 | 860mm DOOR LOWER FRAME SHAPE | 1.000 | PC | | | | | | | | | | | | | | | | | | | | | | | | | | | | | | | | | | | | | | | | | | | | | | | |
| RC1200A0 | ED=4 WIRE D=0.5 H24 COMPRESSIO N SPRING | 2.000 | PC | | | | | | | | | | | | | | | | | | | | | | | | | | | | | | | | | | | | | | | | | | | | | | | |
| VI1220A1 | 4,2x12 TCB SELF-TAPPIN G SCREW | 1.000 | PC | | | | | | | | | | | | | | | | | | | | | | | | | | | | | | | | | | | | | | | | | | | | | | | |
| VI1996A0 | M5x35 SCREW | 7.000 | PC | | | | | | | | | | | | | | | | | | | | | | | | | | | | | | | | | | | | | | | | | | | | | | | |
| VM1794A0 | 250x4.8 PA66 BLACK CLAMP | 2.000 | PC | | | | | | | | | | | | | | | | | | | | | | | | | | | | | | | | | | | | | | | | | | | | | | | |
| VM2259A1 | 6 SERIES DOOR LOWER LEFT CAP | 1.000 | PC | | | | | | | | | | | | | | | | | | | | | | | | | | | | | | | | | | | | | | | | | | | | | | | |
| VM2261A1 | MM DOOR LOWER RIGHT CAP | 1.000 | PC | | | | | | | | | | | | | | | | | | | | | | | | | | | | | | | | | | | | | | | | | | | | | | | |
| VM2267A1 | INNER GLASS LOCKING SYSTEM SLIDER | 1.000 | PC | | | | | | | | | | | | | | | | | | | | | | | | | | | | | | | | | | | | | | | | | | | | | | | |
| VM2269A0 | INTERNAL GLASS LOCKING SYSTEM CAP | 1.000 | PC | | | | | | | | | | | | | | | | | | | | | | | | | | | | | | | | | | | | | | | | | | | | | | | |
| VM2274A0 | GROOVED BUSHING | 1.000 | PC | | | | | | | | | | | | | | | | | | | | | | | | | | | | | | | | | | | | | | | | | | | | | | | |
| VM2305A0 | MM SERIES DOOR CAP FIXING PAWL | 7.000 | PC | | | | | | | | | | | | | | | | | | | | | | | | | | | | | | | | | | | | | | | | | | | | | | | |
| K0B1126AL | EU AND 2/1 MM LEFT DOOR LOWER BEAM KIT | <table border="1"> <thead> <tr> <th>Code</th> <th>Description</th> <th>Qty</th> <th>UOM</th> </tr> </thead> <tbody> <tr> <td>0B1126A1</td> <td>860mm DOOR LOWER FRAME SHAPE</td> <td>1.000</td> <td>PC</td> </tr> <tr> <td>RC1200A0</td> <td>ED=4 WIRE D=0.5 H24 COMPRESSIO N SPRING</td> <td>2.000</td> <td>PC</td> </tr> <tr> <td>VI1220A1</td> <td>4,2x12 TCB SELF-TAPPIN G SCREW</td> <td>1.000</td> <td>PC</td> </tr> <tr> <td>VI1996A0</td> <td>M5x35 SCREW</td> <td>7.000</td> <td>PC</td> </tr> <tr> <td>VM1794A0</td> <td>250x4.8 PA66 BLACK CLAMP</td> <td>2.000</td> <td>PC</td> </tr> <tr> <td>VM2267A1</td> <td>INNER GLASS LOCKING SYSTEM SLIDER</td> <td>1.000</td> <td>PC</td> </tr> </tbody> </table> | Code | Description | Qty | UOM | 0B1126A1 | 860mm DOOR LOWER FRAME SHAPE | 1.000 | PC | RC1200A0 | ED=4 WIRE D=0.5 H24 COMPRESSIO N SPRING | 2.000 | PC | VI1220A1 | 4,2x12 TCB SELF-TAPPIN G SCREW | 1.000 | PC | VI1996A0 | M5x35 SCREW | 7.000 | PC | VM1794A0 | 250x4.8 PA66 BLACK CLAMP | 2.000 | PC | VM2267A1 | INNER GLASS LOCKING SYSTEM SLIDER | 1.000 | PC | | | | | | | | | | | | | | | | | | | | |
| Code | Description | Qty | UOM | | | | | | | | | | | | | | | | | | | | | | | | | | | | | | | | | | | | | | | | | | | | | | | |
| 0B1126A1 | 860mm DOOR LOWER FRAME SHAPE | 1.000 | PC | | | | | | | | | | | | | | | | | | | | | | | | | | | | | | | | | | | | | | | | | | | | | | | |
| RC1200A0 | ED=4 WIRE D=0.5 H24 COMPRESSIO N SPRING | 2.000 | PC | | | | | | | | | | | | | | | | | | | | | | | | | | | | | | | | | | | | | | | | | | | | | | | |
| VI1220A1 | 4,2x12 TCB SELF-TAPPIN G SCREW | 1.000 | PC | | | | | | | | | | | | | | | | | | | | | | | | | | | | | | | | | | | | | | | | | | | | | | | |
| VI1996A0 | M5x35 SCREW | 7.000 | PC | | | | | | | | | | | | | | | | | | | | | | | | | | | | | | | | | | | | | | | | | | | | | | | |
| VM1794A0 | 250x4.8 PA66 BLACK CLAMP | 2.000 | PC | | | | | | | | | | | | | | | | | | | | | | | | | | | | | | | | | | | | | | | | | | | | | | | |
| VM2267A1 | INNER GLASS LOCKING SYSTEM SLIDER | 1.000 | PC | | | | | | | | | | | | | | | | | | | | | | | | | | | | | | | | | | | | | | | | | | | | | | | |



| COMPONENT | | | SPARE PART | | | | | | | | | | | | | | | | | | | | | | | | | | | | | | | | | | | | | | | | | | | |
|-----------|--|---|------------|--|--|------|-------------|------------------------------------|-------|----------|--|--|-------|----------|--------------------|--------------------------------------|-------|----------|--------------------------------------|-------------|-------|----------|------------------------------------|------------------------------------|-------|----------|-----------------------------------|-------------------------------|-------|----|----------|--|-------|----|----------|--|-------|----|----------|--------------------|-------|----|----------|--------------------------------------|-------|----|
| Code | Description | Image | Code | Description | Kit components | | | | | | | | | | | | | | | | | | | | | | | | | | | | | | | | | | | | | | | | | |
| VM2274A | GROOVED BUSHING |  | K0B1126AL | EU AND 2/1 MM LEFT DOOR LOWER BEAM KIT | <table border="1"> <thead> <tr> <th>Code</th> <th>Description</th> <th>Qty</th> <th>UOM</th> </tr> </thead> <tbody> <tr> <td>VM2269A0</td> <td>INTERNAL GLASS LOCKING SYSTEM CAP</td> <td>1.000</td> <td>PC</td> </tr> <tr> <td>VM2274A0</td> <td>GROOVED BUSHING</td> <td>1.000</td> <td>PC</td> </tr> <tr> <td>VM2305A0</td> <td>MM SERIES DOOR CAP FIXING PAWL</td> <td>7.000</td> <td>PC</td> </tr> <tr> <td>VM2384A0</td> <td>MM LEFT DOOR RIGHT LOWER CAP</td> <td>1.000</td> <td>PC</td> </tr> <tr> <td>VM2386A1</td> <td>LEFT MM DOOR LOWER LEFT CAP</td> <td>1.000</td> <td>PC</td> </tr> </tbody> </table> | Code | Description | Qty | UOM | VM2269A0 | INTERNAL GLASS LOCKING SYSTEM CAP | 1.000 | PC | VM2274A0 | GROOVED BUSHING | 1.000 | PC | VM2305A0 | MM SERIES DOOR CAP FIXING PAWL | 7.000 | PC | VM2384A0 | MM LEFT DOOR RIGHT LOWER CAP | 1.000 | PC | VM2386A1 | LEFT MM DOOR LOWER LEFT CAP | 1.000 | PC | | | | | | | | | | | | | | | | | |
| | | | Code | Description | Qty | UOM | | | | | | | | | | | | | | | | | | | | | | | | | | | | | | | | | | | | | | | | |
| | | | VM2269A0 | INTERNAL GLASS LOCKING SYSTEM CAP | 1.000 | PC | | | | | | | | | | | | | | | | | | | | | | | | | | | | | | | | | | | | | | | | |
| VM2274A0 | GROOVED BUSHING | 1.000 | PC | | | | | | | | | | | | | | | | | | | | | | | | | | | | | | | | | | | | | | | | | | | |
| VM2305A0 | MM SERIES DOOR CAP FIXING PAWL | 7.000 | PC | | | | | | | | | | | | | | | | | | | | | | | | | | | | | | | | | | | | | | | | | | | |
| VM2384A0 | MM LEFT DOOR RIGHT LOWER CAP | 1.000 | PC | | | | | | | | | | | | | | | | | | | | | | | | | | | | | | | | | | | | | | | | | | | |
| VM2386A1 | LEFT MM DOOR LOWER LEFT CAP | 1.000 | PC | | | | | | | | | | | | | | | | | | | | | | | | | | | | | | | | | | | | | | | | | | | |
| K0B1122AR | CHEFTOP MM RIGHT DOOR LOWER BEAM KIT | <table border="1"> <thead> <tr> <th>Code</th> <th>Description</th> <th>Qty</th> <th>UOM</th> </tr> </thead> <tbody> <tr> <td>0B1122A1</td> <td>750MM DOOR LOWER FRAME SHAPE</td> <td>1.000</td> <td>PC</td> </tr> <tr> <td>RC1200A0</td> <td>ED=4 WIRE D=0.5 H24 COMPRESSIO N SPRING</td> <td>2.000</td> <td>PC</td> </tr> <tr> <td>VI1220A1</td> <td>4,2x12 TCB SELF-TAPPIN G SCREW</td> <td>1.000</td> <td>PC</td> </tr> <tr> <td>VI1996A0</td> <td>M5x35 SCREW</td> <td>7.000</td> <td>PC</td> </tr> <tr> <td>VM2259A1</td> <td>6 SERIES DOOR LOWER LEFT CAP</td> <td>1.000</td> <td>PC</td> </tr> <tr> <td>VM2261A1</td> <td>MM DOOR LOWER RIGHT CAP</td> <td>1.000</td> <td>PC</td> </tr> <tr> <td>VM2267A1</td> <td>INNER GLASS LOCKING SYSTEM SLIDER</td> <td>1.000</td> <td>PC</td> </tr> <tr> <td>VM2269A0</td> <td>INTERNAL GLASS LOCKING SYSTEM CAP</td> <td>1.000</td> <td>PC</td> </tr> <tr> <td>VM2274A0</td> <td>GROOVED BUSHING</td> <td>1.000</td> <td>PC</td> </tr> <tr> <td>VM2305A0</td> <td>MM SERIES DOOR CAP FIXING PAWL</td> <td>7.000</td> <td>PC</td> </tr> </tbody> </table> | Code | Description | Qty | UOM | 0B1122A1 | 750MM DOOR LOWER FRAME SHAPE | 1.000 | PC | RC1200A0 | ED=4 WIRE D=0.5 H24 COMPRESSIO N SPRING | 2.000 | PC | VI1220A1 | 4,2x12 TCB SELF-TAPPIN G SCREW | 1.000 | PC | VI1996A0 | M5x35 SCREW | 7.000 | PC | VM2259A1 | 6 SERIES DOOR LOWER LEFT CAP | 1.000 | PC | VM2261A1 | MM DOOR LOWER RIGHT CAP | 1.000 | PC | VM2267A1 | INNER GLASS LOCKING SYSTEM SLIDER | 1.000 | PC | VM2269A0 | INTERNAL GLASS LOCKING SYSTEM CAP | 1.000 | PC | VM2274A0 | GROOVED BUSHING | 1.000 | PC | VM2305A0 | MM SERIES DOOR CAP FIXING PAWL | 7.000 | PC |
| Code | Description | Qty | UOM | | | | | | | | | | | | | | | | | | | | | | | | | | | | | | | | | | | | | | | | | | | |
| 0B1122A1 | 750MM DOOR LOWER FRAME SHAPE | 1.000 | PC | | | | | | | | | | | | | | | | | | | | | | | | | | | | | | | | | | | | | | | | | | | |
| RC1200A0 | ED=4 WIRE D=0.5 H24 COMPRESSIO N SPRING | 2.000 | PC | | | | | | | | | | | | | | | | | | | | | | | | | | | | | | | | | | | | | | | | | | | |
| VI1220A1 | 4,2x12 TCB SELF-TAPPIN G SCREW | 1.000 | PC | | | | | | | | | | | | | | | | | | | | | | | | | | | | | | | | | | | | | | | | | | | |
| VI1996A0 | M5x35 SCREW | 7.000 | PC | | | | | | | | | | | | | | | | | | | | | | | | | | | | | | | | | | | | | | | | | | | |
| VM2259A1 | 6 SERIES DOOR LOWER LEFT CAP | 1.000 | PC | | | | | | | | | | | | | | | | | | | | | | | | | | | | | | | | | | | | | | | | | | | |
| VM2261A1 | MM DOOR LOWER RIGHT CAP | 1.000 | PC | | | | | | | | | | | | | | | | | | | | | | | | | | | | | | | | | | | | | | | | | | | |
| VM2267A1 | INNER GLASS LOCKING SYSTEM SLIDER | 1.000 | PC | | | | | | | | | | | | | | | | | | | | | | | | | | | | | | | | | | | | | | | | | | | |
| VM2269A0 | INTERNAL GLASS LOCKING SYSTEM CAP | 1.000 | PC | | | | | | | | | | | | | | | | | | | | | | | | | | | | | | | | | | | | | | | | | | | |
| VM2274A0 | GROOVED BUSHING | 1.000 | PC | | | | | | | | | | | | | | | | | | | | | | | | | | | | | | | | | | | | | | | | | | | |
| VM2305A0 | MM SERIES DOOR CAP FIXING PAWL | 7.000 | PC | | | | | | | | | | | | | | | | | | | | | | | | | | | | | | | | | | | | | | | | | | | |
| K0B1122AL | CHEFTOP MM LEFT DOOR LOWER BEAM KIT | <table border="1"> <thead> <tr> <th>Code</th> <th>Description</th> <th>Qty</th> <th>UOM</th> </tr> </thead> <tbody> <tr> <td>0B1122A1</td> <td>750MM DOOR LOWER FRAME SHAPE</td> <td>1.000</td> <td>PC</td> </tr> </tbody> </table> | Code | Description | Qty | UOM | 0B1122A1 | 750MM DOOR LOWER FRAME SHAPE | 1.000 | PC | | | | | | | | | | | | | | | | | | | | | | | | | | | | | | | | | | | | |
| Code | Description | Qty | UOM | | | | | | | | | | | | | | | | | | | | | | | | | | | | | | | | | | | | | | | | | | | |
| 0B1122A1 | 750MM DOOR LOWER FRAME SHAPE | 1.000 | PC | | | | | | | | | | | | | | | | | | | | | | | | | | | | | | | | | | | | | | | | | | | |



| COMPONENT | | | SPARE PART | | | | | | | | | | | | | | | | | | | | | | | | | | | | | | | | | | | | | | | | | | | | | | |
|-----------|--|---|------------|-------------------------------------|---|------|-------------|-----|-----|----------|--|-------|----|----------|--------------------------------------|-------|----|----------|--------------------------------------|-------|----|----------|--|-------|----|----------|--|-------|----|----------|--|-------|----|----------|--------------------|-------|----|----------|--------------------------------------|-------|----|----------|------------------------------------|-------|----|----------|-----------------------------------|-------|----|
| Code | Description | Image | Code | Description | Kit components | | | | | | | | | | | | | | | | | | | | | | | | | | | | | | | | | | | | | | | | | | | | |
| VM2274A | GROOVED BUSHING |  | K0B1122AL | CHEFTOP MM LEFT DOOR LOWER BEAM KIT | <table border="1"> <thead> <tr> <th>Code</th> <th>Description</th> <th>Qty</th> <th>UOM</th> </tr> </thead> <tbody> <tr> <td>RC1200A0</td> <td>ED=4 WIRE D=0.5 H24 COMPRESSIO N SPRING</td> <td>2.000</td> <td>PC</td> </tr> <tr> <td>VI1220A1</td> <td>4,2x12 TCB SELF-TAPPIN G SCREW</td> <td>1.000</td> <td>PC</td> </tr> <tr> <td>VI1996A0</td> <td>M5x35 SCREW</td> <td>7.000</td> <td>PC</td> </tr> <tr> <td>VM1794A0</td> <td>250x4.8 PA66 BLACK CLAMP</td> <td>2.000</td> <td>PC</td> </tr> <tr> <td>VM2267A1</td> <td>INNER GLASS LOCKING SYSTEM SLIDER</td> <td>1.000</td> <td>PC</td> </tr> <tr> <td>VM2269A0</td> <td>INTERNAL GLASS LOCKING SYSTEM CAP</td> <td>1.000</td> <td>PC</td> </tr> <tr> <td>VM2274A0</td> <td>GROOVED BUSHING</td> <td>1.000</td> <td>PC</td> </tr> <tr> <td>VM2305A0</td> <td>MM SERIES DOOR CAP FIXING PAWL</td> <td>7.000</td> <td>PC</td> </tr> <tr> <td>VM2384A0</td> <td>MM LEFT DOOR RIGHT LOWER CAP</td> <td>1.000</td> <td>PC</td> </tr> <tr> <td>VM2386A1</td> <td>LEFT MM DOOR LOWER LEFT CAP</td> <td>1.000</td> <td>PC</td> </tr> </tbody> </table> | Code | Description | Qty | UOM | RC1200A0 | ED=4 WIRE D=0.5 H24 COMPRESSIO N SPRING | 2.000 | PC | VI1220A1 | 4,2x12 TCB SELF-TAPPIN G SCREW | 1.000 | PC | VI1996A0 | M5x35 SCREW | 7.000 | PC | VM1794A0 | 250x4.8 PA66 BLACK CLAMP | 2.000 | PC | VM2267A1 | INNER GLASS LOCKING SYSTEM SLIDER | 1.000 | PC | VM2269A0 | INTERNAL GLASS LOCKING SYSTEM CAP | 1.000 | PC | VM2274A0 | GROOVED BUSHING | 1.000 | PC | VM2305A0 | MM SERIES DOOR CAP FIXING PAWL | 7.000 | PC | VM2384A0 | MM LEFT DOOR RIGHT LOWER CAP | 1.000 | PC | VM2386A1 | LEFT MM DOOR LOWER LEFT CAP | 1.000 | PC |
| Code | Description | Qty | UOM | | | | | | | | | | | | | | | | | | | | | | | | | | | | | | | | | | | | | | | | | | | | | | |
| RC1200A0 | ED=4 WIRE D=0.5 H24 COMPRESSIO N SPRING | 2.000 | PC | | | | | | | | | | | | | | | | | | | | | | | | | | | | | | | | | | | | | | | | | | | | | | |
| VI1220A1 | 4,2x12 TCB SELF-TAPPIN G SCREW | 1.000 | PC | | | | | | | | | | | | | | | | | | | | | | | | | | | | | | | | | | | | | | | | | | | | | | |
| VI1996A0 | M5x35 SCREW | 7.000 | PC | | | | | | | | | | | | | | | | | | | | | | | | | | | | | | | | | | | | | | | | | | | | | | |
| VM1794A0 | 250x4.8 PA66 BLACK CLAMP | 2.000 | PC | | | | | | | | | | | | | | | | | | | | | | | | | | | | | | | | | | | | | | | | | | | | | | |
| VM2267A1 | INNER GLASS LOCKING SYSTEM SLIDER | 1.000 | PC | | | | | | | | | | | | | | | | | | | | | | | | | | | | | | | | | | | | | | | | | | | | | | |
| VM2269A0 | INTERNAL GLASS LOCKING SYSTEM CAP | 1.000 | PC | | | | | | | | | | | | | | | | | | | | | | | | | | | | | | | | | | | | | | | | | | | | | | |
| VM2274A0 | GROOVED BUSHING | 1.000 | PC | | | | | | | | | | | | | | | | | | | | | | | | | | | | | | | | | | | | | | | | | | | | | | |
| VM2305A0 | MM SERIES DOOR CAP FIXING PAWL | 7.000 | PC | | | | | | | | | | | | | | | | | | | | | | | | | | | | | | | | | | | | | | | | | | | | | | |
| VM2384A0 | MM LEFT DOOR RIGHT LOWER CAP | 1.000 | PC | | | | | | | | | | | | | | | | | | | | | | | | | | | | | | | | | | | | | | | | | | | | | | |
| VM2386A1 | LEFT MM DOOR LOWER LEFT CAP | 1.000 | PC | | | | | | | | | | | | | | | | | | | | | | | | | | | | | | | | | | | | | | | | | | | | | | |
| VM2275A | SMOOTH BUSHING |  | KVM2275A | SMOOTH PIN BUSHING KIT | <table border="1"> <thead> <tr> <th>Code</th> <th>Description</th> <th>Qty</th> <th>UOM</th> </tr> </thead> <tbody> <tr> <td>VM2275A0</td> <td>SMOOTH BUSHING</td> <td>1.000</td> <td>PC</td> </tr> </tbody> </table> | Code | Description | Qty | UOM | VM2275A0 | SMOOTH BUSHING | 1.000 | PC | | | | | | | | | | | | | | | | | | | | | | | | | | | | | | | | | | | | |
| Code | Description | Qty | UOM | | | | | | | | | | | | | | | | | | | | | | | | | | | | | | | | | | | | | | | | | | | | | | |
| VM2275A0 | SMOOTH BUSHING | 1.000 | PC | | | | | | | | | | | | | | | | | | | | | | | | | | | | | | | | | | | | | | | | | | | | | | |
| VT1219A | 557x364x4 SP ELENA BLACK EXTERNAL GLASS |  | KVT1219A | ELENA BL SPRO EXT BLACK GLASS KIT | <table border="1"> <thead> <tr> <th>Code</th> <th>Description</th> <th>Qty</th> <th>UOM</th> </tr> </thead> <tbody> <tr> <td>0B0386A0</td> <td>SP STE-ELE EXT GLASS SUPPORT PROFILE</td> <td>2.000</td> <td>PC</td> </tr> <tr> <td>SL1185A1</td> <td></td> <td>2.000</td> <td>PC</td> </tr> <tr> <td>VI1220A1</td> <td>4,2x12 TCB SELF-TAPPIN G SCREW</td> <td>6.000</td> <td>PC</td> </tr> <tr> <td>VT1219A0</td> <td>557x364x4 SP ELENA BLACK EXTERNAL GLASS</td> <td>1.000</td> <td>PC</td> </tr> </tbody> </table> | Code | Description | Qty | UOM | 0B0386A0 | SP STE-ELE EXT GLASS SUPPORT PROFILE | 2.000 | PC | SL1185A1 | | 2.000 | PC | VI1220A1 | 4,2x12 TCB SELF-TAPPIN G SCREW | 6.000 | PC | VT1219A0 | 557x364x4 SP ELENA BLACK EXTERNAL GLASS | 1.000 | PC | | | | | | | | | | | | | | | | | | | | | | | | |
| Code | Description | Qty | UOM | | | | | | | | | | | | | | | | | | | | | | | | | | | | | | | | | | | | | | | | | | | | | | |
| 0B0386A0 | SP STE-ELE EXT GLASS SUPPORT PROFILE | 2.000 | PC | | | | | | | | | | | | | | | | | | | | | | | | | | | | | | | | | | | | | | | | | | | | | | |
| SL1185A1 | | 2.000 | PC | | | | | | | | | | | | | | | | | | | | | | | | | | | | | | | | | | | | | | | | | | | | | | |
| VI1220A1 | 4,2x12 TCB SELF-TAPPIN G SCREW | 6.000 | PC | | | | | | | | | | | | | | | | | | | | | | | | | | | | | | | | | | | | | | | | | | | | | | |
| VT1219A0 | 557x364x4 SP ELENA BLACK EXTERNAL GLASS | 1.000 | PC | | | | | | | | | | | | | | | | | | | | | | | | | | | | | | | | | | | | | | | | | | | | | | |



| COMPONENT | | | SPARE PART | | | | | |
|-----------|---|---|------------|--------------------------------------|----------------|---|------------|------------|
| Code | Description | Image | Code | Description | Kit components | | | |
| VT1346A | SP ELENA FLAG DOOR INNER GLASS+HINGES |  | KVT1346A | BL SP ELENA INT LATERAL GLASS KIT | Code | Description | Qty | UOM |
| | | | | | CR1103A0 | INTERNAL GLASS ST. STEEL UPPER HINGE | 1.000 | PC |
| | | | | | CR1104A0 | INTERNAL GLASS ST. STEEL LOWER HINGE | 1.000 | PC |
| | | | | | VI1810A0 | M6X6 STAINLESS STEEL FLATHEAD SCREW | 6.000 | PC |
| | | | | | VM2399A0 | DOOR HINGES HEADLESS SCREWS COVER | 2.000 | PC |
| | | | | | VM2476A0 | BL SP H6 INTERNAL GLASS HINGE GASKET | 2.000 | PC |
| | | | | | VT1331A0 | SP ELENA 715x318.5x6 INNER GLASS | 1.000 | PC |

ASM8226A/0.D00 - Electrical system - FRONT

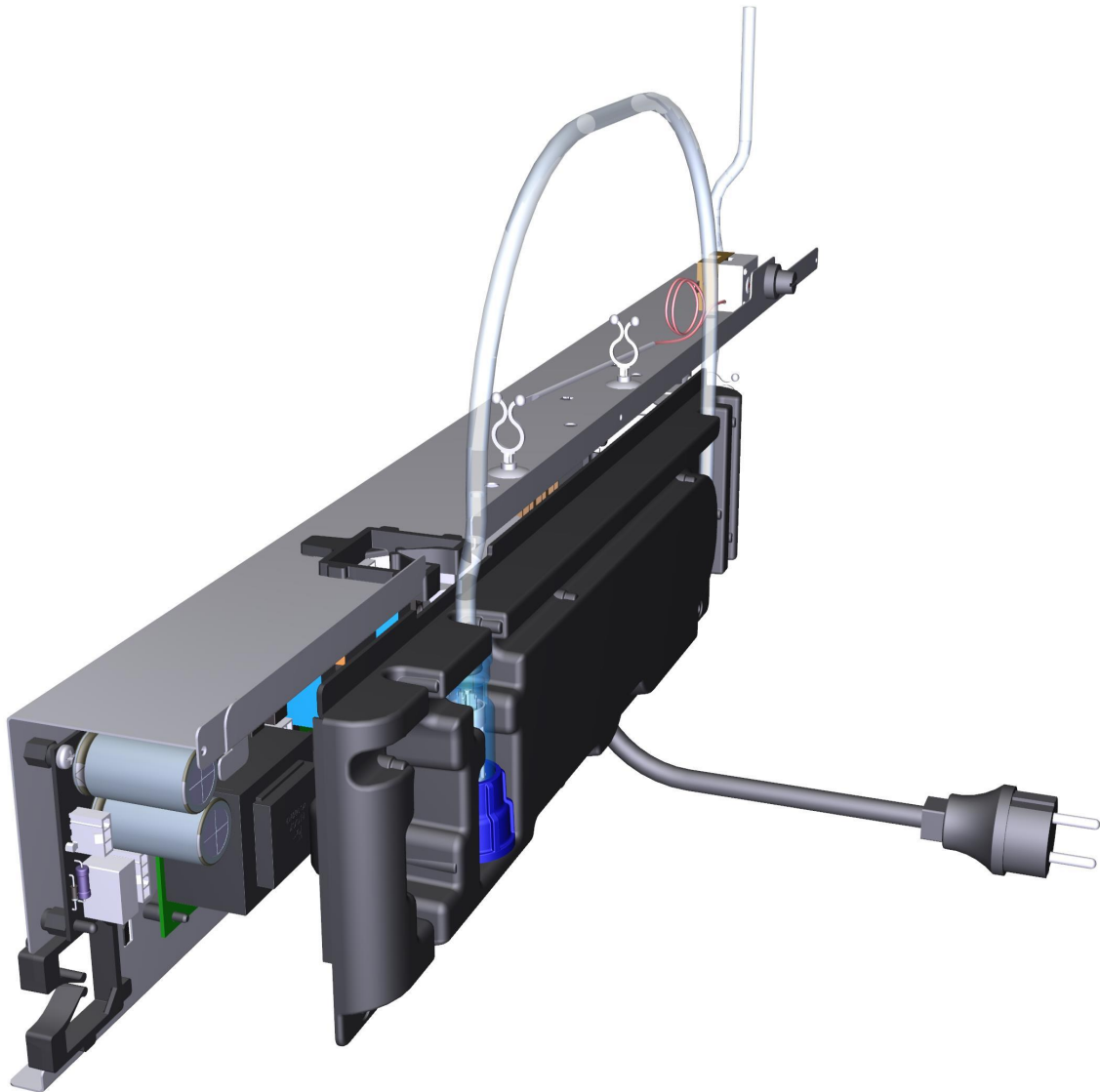





ASM8226A/0.D00 - Electrical system - REAR







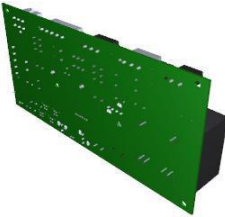

| COMPONENT | | | SPARE PART | | | | | | | | | | | | | | | | | | | | | | | | | | |
|-----------|--|---|------------|---|---|------|-------------|-----|-----|----------|-----------------------------------|-------|----|----------|--------------------------------|-------|----|----------|--|-------|----|----------|-----------------------------------|-------|----|----------|--|-------|----|
| Code | Description | Image | Code | Description | Kit components | | | | | | | | | | | | | | | | | | | | | | | | |
| 0P1032A | SP ELE-ROS EL COMPONENTS HOLDER |  | 0P1032A0 | SP ELE-ROS EL COMPONENTS HOLDER | | | | | | | | | | | | | | | | | | | | | | | | | |
| VE1115A | 20 A 230V 4 POLES MINICONTRACTOR |  | KVE1115A | 20A 230V 4 POLES MINICONTRACTOR KI | <table border="1"> <thead> <tr> <th>Code</th> <th>Description</th> <th>Qty</th> <th>UOM</th> </tr> </thead> <tbody> <tr> <td>VE1115A0</td> <td>20 A 230V 4 POLES MINICONTRACTOR</td> <td>1.000</td> <td>PC</td> </tr> <tr> <td>VM1075A1</td> <td>PLASTIC CLIP TO FIX CONTACTORS</td> <td>4.000</td> <td>PC</td> </tr> </tbody> </table> | Code | Description | Qty | UOM | VE1115A0 | 20 A 230V 4 POLES MINICONTRACTOR | 1.000 | PC | VM1075A1 | PLASTIC CLIP TO FIX CONTACTORS | 4.000 | PC | | | | | | | | | | | | |
| Code | Description | Qty | UOM | | | | | | | | | | | | | | | | | | | | | | | | | | |
| VE1115A0 | 20 A 230V 4 POLES MINICONTRACTOR | 1.000 | PC | | | | | | | | | | | | | | | | | | | | | | | | | | |
| VM1075A1 | PLASTIC CLIP TO FIX CONTACTORS | 4.000 | PC | | | | | | | | | | | | | | | | | | | | | | | | | | |
| VM1056A | SMALL CONTACTOR BRACKET VE1115A |  | VM1056A0 | SMALL CONTACTOR BRACKET VE1115A | | | | | | | | | | | | | | | | | | | | | | | | | |
| VL1145A | VL1145A1 |  | KVL1145A | 3/4-JG8 FITTING WITH FILTER AND NRV KIT | <table border="1"> <thead> <tr> <th>Code</th> <th>Description</th> <th>Qty</th> <th>UOM</th> </tr> </thead> <tbody> <tr> <td>VL1145A1</td> <td>VL1145A1</td> <td>1.000</td> <td>PC</td> </tr> </tbody> </table> | Code | Description | Qty | UOM | VL1145A1 | VL1145A1 | 1.000 | PC | | | | | | | | | | | | | | | | |
| Code | Description | Qty | UOM | | | | | | | | | | | | | | | | | | | | | | | | | | |
| VL1145A1 | VL1145A1 | 1.000 | PC | | | | | | | | | | | | | | | | | | | | | | | | | | |
| PE2117A | BLSP ELECTROMECHANICAL LOCK BOARD |  | KPE2117A | ELECTRIC LOCKING SYSTEM BOARD KIT 230V | <table border="1"> <thead> <tr> <th>Code</th> <th>Description</th> <th>Qty</th> <th>UOM</th> </tr> </thead> <tbody> <tr> <td>PE2117A0</td> <td>BLSP ELECTROMECHANICAL LOCK BOARD</td> <td>1.000</td> <td>PC</td> </tr> <tr> <td>VI1850A0</td> <td>TCB M4x6 SCREW</td> <td>2.000</td> <td>PC</td> </tr> <tr> <td>VM1447A0</td> <td></td> <td>0.500</td> <td>PC</td> </tr> <tr> <td>VM1746A0</td> <td>H10 M4 JOINT BOARD FASTENING CLIP</td> <td>2.000</td> <td>PC</td> </tr> <tr> <td>VM1747A0</td> <td>JOINT-PIN H10 POWER BOARD FASTENING CLIP</td> <td>2.000</td> <td>PC</td> </tr> </tbody> </table> | Code | Description | Qty | UOM | PE2117A0 | BLSP ELECTROMECHANICAL LOCK BOARD | 1.000 | PC | VI1850A0 | TCB M4x6 SCREW | 2.000 | PC | VM1447A0 | | 0.500 | PC | VM1746A0 | H10 M4 JOINT BOARD FASTENING CLIP | 2.000 | PC | VM1747A0 | JOINT-PIN H10 POWER BOARD FASTENING CLIP | 2.000 | PC |
| Code | Description | Qty | UOM | | | | | | | | | | | | | | | | | | | | | | | | | | |
| PE2117A0 | BLSP ELECTROMECHANICAL LOCK BOARD | 1.000 | PC | | | | | | | | | | | | | | | | | | | | | | | | | | |
| VI1850A0 | TCB M4x6 SCREW | 2.000 | PC | | | | | | | | | | | | | | | | | | | | | | | | | | |
| VM1447A0 | | 0.500 | PC | | | | | | | | | | | | | | | | | | | | | | | | | | |
| VM1746A0 | H10 M4 JOINT BOARD FASTENING CLIP | 2.000 | PC | | | | | | | | | | | | | | | | | | | | | | | | | | |
| VM1747A0 | JOINT-PIN H10 POWER BOARD FASTENING CLIP | 2.000 | PC | | | | | | | | | | | | | | | | | | | | | | | | | | |

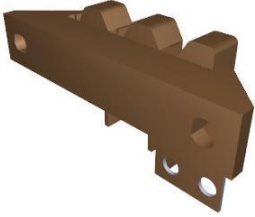



| COMPONENT | | | SPARE PART | | | | | | | | | | | | | | | | | | | | | | | | | | |
|-----------|--|---|------------|---------------------------------|---|------|-------------|-----|-----|----------|--|--------|----|----------|---------------------------------------|-------|----|----------|----------------------------|-------|----|----------|--|-------|----|----------|-----------------------------------|-------|----|
| Code | Description | Image | Code | Description | Kit components | | | | | | | | | | | | | | | | | | | | | | | | |
| VM1746A | H10 M4 JOINT BOARD FASTENING CLIP |  | KVM1746A | BOARD FIXING CLIP JOINT-M4 KIT | <table border="1"> <thead> <tr> <th>Code</th> <th>Description</th> <th>Qty</th> <th>UOM</th> </tr> </thead> <tbody> <tr> <td>VM1746A0</td> <td>H10 M4 JOINT BOARD FASTENING CLIP</td> <td>10.000</td> <td>PC</td> </tr> </tbody> </table> | Code | Description | Qty | UOM | VM1746A0 | H10 M4 JOINT BOARD FASTENING CLIP | 10.000 | PC | | | | | | | | | | | | | | | | |
| Code | Description | Qty | UOM | | | | | | | | | | | | | | | | | | | | | | | | | | |
| VM1746A0 | H10 M4 JOINT BOARD FASTENING CLIP | 10.000 | PC | | | | | | | | | | | | | | | | | | | | | | | | | | |
| VM1747A | JOINT-PIN H10 POWER BOARD FASTENING CLIP |  | KVM1747A | BOARD FIXING CLIP JOINT-PIN KIT | <table border="1"> <thead> <tr> <th>Code</th> <th>Description</th> <th>Qty</th> <th>UOM</th> </tr> </thead> <tbody> <tr> <td>VM1747A0</td> <td>JOINT-PIN H10 POWER BOARD FASTENING CLIP</td> <td>10.000</td> <td>PC</td> </tr> </tbody> </table> | Code | Description | Qty | UOM | VM1747A0 | JOINT-PIN H10 POWER BOARD FASTENING CLIP | 10.000 | PC | | | | | | | | | | | | | | | | |
| Code | Description | Qty | UOM | | | | | | | | | | | | | | | | | | | | | | | | | | |
| VM1747A0 | JOINT-PIN H10 POWER BOARD FASTENING CLIP | 10.000 | PC | | | | | | | | | | | | | | | | | | | | | | | | | | |
| PE2260A | BL SHOP.PRO 230V POWER BOARD |  | KPE2260A | BL SHOP.PRO 230V POWER CARD KIT | <table border="1"> <thead> <tr> <th>Code</th> <th>Description</th> <th>Qty</th> <th>UOM</th> </tr> </thead> <tbody> <tr> <td>PE2260A1</td> <td>BL SHOP.PRO 230V POWER BOARD</td> <td>1.000</td> <td>PC</td> </tr> <tr> <td>VI1988A0</td> <td>AUTOTHREAD ING SCREW 4,2x19 TCB+ INOX</td> <td>3.000</td> <td>PC</td> </tr> <tr> <td>VM1187A0</td> <td>POWER BOARD FRAME SHOP.PRO</td> <td>1.000</td> <td>PC</td> </tr> <tr> <td>VM1447A0</td> <td></td> <td>1.000</td> <td>PC</td> </tr> <tr> <td>VM1748A0</td> <td>JOINT-JOINT H10 BOARD FIXING CLIP</td> <td>6.000</td> <td>PC</td> </tr> </tbody> </table> | Code | Description | Qty | UOM | PE2260A1 | BL SHOP.PRO 230V POWER BOARD | 1.000 | PC | VI1988A0 | AUTOTHREAD ING SCREW 4,2x19 TCB+ INOX | 3.000 | PC | VM1187A0 | POWER BOARD FRAME SHOP.PRO | 1.000 | PC | VM1447A0 | | 1.000 | PC | VM1748A0 | JOINT-JOINT H10 BOARD FIXING CLIP | 6.000 | PC |
| Code | Description | Qty | UOM | | | | | | | | | | | | | | | | | | | | | | | | | | |
| PE2260A1 | BL SHOP.PRO 230V POWER BOARD | 1.000 | PC | | | | | | | | | | | | | | | | | | | | | | | | | | |
| VI1988A0 | AUTOTHREAD ING SCREW 4,2x19 TCB+ INOX | 3.000 | PC | | | | | | | | | | | | | | | | | | | | | | | | | | |
| VM1187A0 | POWER BOARD FRAME SHOP.PRO | 1.000 | PC | | | | | | | | | | | | | | | | | | | | | | | | | | |
| VM1447A0 | | 1.000 | PC | | | | | | | | | | | | | | | | | | | | | | | | | | |
| VM1748A0 | JOINT-JOINT H10 BOARD FIXING CLIP | 6.000 | PC | | | | | | | | | | | | | | | | | | | | | | | | | | |
| VM1187A | POWER BOARD FRAME SHOP.PRO |  | VM1187A0 | POWER BOARD FRAME SHOP.PRO | | | | | | | | | | | | | | | | | | | | | | | | | |

| COMPONENT | | | SPARE PART | | | | | | | | | | | | | | | | | | |
|-----------|---|---|------------|---|--|------|-------------|-----|-----|----------|---|--------|----|----------|---------------------------------------|-------|----|----------|--------------------------------------|-------|----|
| Code | Description | Image | Code | Description | Kit components | | | | | | | | | | | | | | | | |
| CE1581A | CABLE H07RNF 3G1.5 L1.5MT+K1/6+SCHU KO |  | KCE1581A | H07RNF 3G1.5 L1.5 MT + SHUKO PLUG KIT | <table border="1"> <thead> <tr> <th>Code</th> <th>Description</th> <th>Qty</th> <th>UOM</th> </tr> </thead> <tbody> <tr> <td>CE1581A0</td> <td>CABLE H07RNF 3G1.5 L1.5MT+K1/6+ SCHUKO</td> <td>1.000</td> <td>PC</td> </tr> </tbody> </table> | Code | Description | Qty | UOM | CE1581A0 | CABLE H07RNF 3G1.5 L1.5MT+K1/6+ SCHUKO | 1.000 | PC | | | | | | | | |
| Code | Description | Qty | UOM | | | | | | | | | | | | | | | | | | |
| CE1581A0 | CABLE H07RNF 3G1.5 L1.5MT+K1/6+ SCHUKO | 1.000 | PC | | | | | | | | | | | | | | | | | | |
| CN1003A | 6,3 Uf MOTOR CAPACITOR |  | KCN1003A | 6,3 uF MOTOR CAPACITOR KIT | <table border="1"> <thead> <tr> <th>Code</th> <th>Description</th> <th>Qty</th> <th>UOM</th> </tr> </thead> <tbody> <tr> <td>CN1003A0</td> <td>6,3 Uf MOTOR CAPACITOR</td> <td>1.000</td> <td>PC</td> </tr> <tr> <td>VI1931A0</td> <td>M8x1.65 H4 CH13 ZINC PLATED NUT</td> <td>1.000</td> <td>PC</td> </tr> <tr> <td>VI1932A0</td> <td>D8 INDENTED ZINC PLATED WASHER</td> <td>1.000</td> <td>PC</td> </tr> </tbody> </table> | Code | Description | Qty | UOM | CN1003A0 | 6,3 Uf MOTOR CAPACITOR | 1.000 | PC | VI1931A0 | M8x1.65 H4 CH13 ZINC PLATED NUT | 1.000 | PC | VI1932A0 | D8 INDENTED ZINC PLATED WASHER | 1.000 | PC |
| Code | Description | Qty | UOM | | | | | | | | | | | | | | | | | | |
| CN1003A0 | 6,3 Uf MOTOR CAPACITOR | 1.000 | PC | | | | | | | | | | | | | | | | | | |
| VI1931A0 | M8x1.65 H4 CH13 ZINC PLATED NUT | 1.000 | PC | | | | | | | | | | | | | | | | | | |
| VI1932A0 | D8 INDENTED ZINC PLATED WASHER | 1.000 | PC | | | | | | | | | | | | | | | | | | |
| MR1025A | 3 POLES 450V 41A+GROUND TERMINAL BLOCK |  | KMR1025A | 3 POLES TERMINAL BLOCK KIT | <table border="1"> <thead> <tr> <th>Code</th> <th>Description</th> <th>Qty</th> <th>UOM</th> </tr> </thead> <tbody> <tr> <td>MR1025A1</td> <td>3 POLES 450V 41A+GROUND TERMINAL BLOCK</td> <td>1.000</td> <td>PC</td> </tr> </tbody> </table> | Code | Description | Qty | UOM | MR1025A1 | 3 POLES 450V 41A+GROUND TERMINAL BLOCK | 1.000 | PC | | | | | | | | |
| Code | Description | Qty | UOM | | | | | | | | | | | | | | | | | | |
| MR1025A1 | 3 POLES 450V 41A+GROUND TERMINAL BLOCK | 1.000 | PC | | | | | | | | | | | | | | | | | | |
| RC1006A | D8 PET PIPE GUIDE BEND |  | KRC1006A | 20 PCS. Ø8 PET PIPE GUIDE BEND KI | <table border="1"> <thead> <tr> <th>Code</th> <th>Description</th> <th>Qty</th> <th>UOM</th> </tr> </thead> <tbody> <tr> <td>RC1006A0</td> <td>D8 PET PIPE GUIDE BEND</td> <td>20.000</td> <td>PC</td> </tr> </tbody> </table> | Code | Description | Qty | UOM | RC1006A0 | D8 PET PIPE GUIDE BEND | 20.000 | PC | | | | | | | | |
| Code | Description | Qty | UOM | | | | | | | | | | | | | | | | | | |
| RC1006A0 | D8 PET PIPE GUIDE BEND | 20.000 | PC | | | | | | | | | | | | | | | | | | |
| TB3283A | TB3283A0 |  | KTB1959A | Ø8 TB1815 TRANSPARENT PIPE 5M KIT | <table border="1"> <thead> <tr> <th>Code</th> <th>Description</th> <th>Qty</th> <th>UOM</th> </tr> </thead> <tbody> <tr> <td>TB1815A0</td> <td>7,93x4,75 PE TRANSP. PIPE (JG #PE08100N)</td> <td>5.000</td> <td>M</td> </tr> </tbody> </table> | Code | Description | Qty | UOM | TB1815A0 | 7,93x4,75 PE TRANSP. PIPE (JG #PE08100N) | 5.000 | M | | | | | | | | |
| Code | Description | Qty | UOM | | | | | | | | | | | | | | | | | | |
| TB1815A0 | 7,93x4,75 PE TRANSP. PIPE (JG #PE08100N) | 5.000 | M | | | | | | | | | | | | | | | | | | |

| COMPONENT | | | SPARE PART | | | | | | | | | | | | | | | | | | | | | | | | | | |
|-----------|--|---|------------|--|---|------|-------------|-----|-----|----------|--|--------|----|----------|-----------------------------------|-------|----|----------|-------------------------------------|-------|----|----------|---------------------------------------|-------|----|----------|--------------------------------|-------|----|
| Code | Description | Image | Code | Description | Kit components | | | | | | | | | | | | | | | | | | | | | | | | |
| TR1136A | 318°C -0/+24 1 POLE SAFETY THERMOSTAT |  | KTR1136A | 318°C -0/+24 SAFETY THERMOSTAT KIT | <table border="1"> <thead> <tr> <th>Code</th> <th>Description</th> <th>Qty</th> <th>UOM</th> </tr> </thead> <tbody> <tr> <td>0H8120A0</td> <td>XEVL BULB PASS-THROU GH COVER</td> <td>1.000</td> <td>PC</td> </tr> <tr> <td>GN1531A0</td> <td>THERMOSTAT BULB INLET SEALING</td> <td>1.000</td> <td>PC</td> </tr> <tr> <td>SL1045A0</td> <td>S57 BLACK SILICONE - 80ml CARTRIDGE</td> <td>1.000</td> <td>PC</td> </tr> <tr> <td>TR1136A0</td> <td>318°C -0/+24 1 POLE SAFETY THERMOSTAT</td> <td>1.000</td> <td>PC</td> </tr> <tr> <td>VI1220A1</td> <td>4.2x12 TCB SELF-TAPPIN G SCREW</td> <td>3.000</td> <td>PC</td> </tr> </tbody> </table> | Code | Description | Qty | UOM | 0H8120A0 | XEVL BULB PASS-THROU GH COVER | 1.000 | PC | GN1531A0 | THERMOSTAT BULB INLET SEALING | 1.000 | PC | SL1045A0 | S57 BLACK SILICONE - 80ml CARTRIDGE | 1.000 | PC | TR1136A0 | 318°C -0/+24 1 POLE SAFETY THERMOSTAT | 1.000 | PC | VI1220A1 | 4.2x12 TCB SELF-TAPPIN G SCREW | 3.000 | PC |
| Code | Description | Qty | UOM | | | | | | | | | | | | | | | | | | | | | | | | | | |
| 0H8120A0 | XEVL BULB PASS-THROU GH COVER | 1.000 | PC | | | | | | | | | | | | | | | | | | | | | | | | | | |
| GN1531A0 | THERMOSTAT BULB INLET SEALING | 1.000 | PC | | | | | | | | | | | | | | | | | | | | | | | | | | |
| SL1045A0 | S57 BLACK SILICONE - 80ml CARTRIDGE | 1.000 | PC | | | | | | | | | | | | | | | | | | | | | | | | | | |
| TR1136A0 | 318°C -0/+24 1 POLE SAFETY THERMOSTAT | 1.000 | PC | | | | | | | | | | | | | | | | | | | | | | | | | | |
| VI1220A1 | 4.2x12 TCB SELF-TAPPIN G SCREW | 3.000 | PC | | | | | | | | | | | | | | | | | | | | | | | | | | |
| VI1328A | VI1328A0 |  | VI1328A0 | VI1328A0 | | | | | | | | | | | | | | | | | | | | | | | | | |
| VM1188A | POWER BOARD WIRES PASS-THROUGH |  | KVM1188A | POWER BOARD WIRES PASS-THROUGH 10PCS KIT | <table border="1"> <thead> <tr> <th>Code</th> <th>Description</th> <th>Qty</th> <th>UOM</th> </tr> </thead> <tbody> <tr> <td>VM1188A0</td> <td>POWER BOARD WIRES PASS-THROU GH</td> <td>10.000</td> <td>PC</td> </tr> </tbody> </table> | Code | Description | Qty | UOM | VM1188A0 | POWER BOARD WIRES PASS-THROU GH | 10.000 | PC | | | | | | | | | | | | | | | | |
| Code | Description | Qty | UOM | | | | | | | | | | | | | | | | | | | | | | | | | | |
| VM1188A0 | POWER BOARD WIRES PASS-THROU GH | 10.000 | PC | | | | | | | | | | | | | | | | | | | | | | | | | | |
| VM2482A | ELECTR COMPONENTS HOLDER FRAME SHOP.PRO |  | KVM2482A | BAKERLUX SP ELECTR COMPONENTS HOLDER KIT | <table border="1"> <thead> <tr> <th>Code</th> <th>Description</th> <th>Qty</th> <th>UOM</th> </tr> </thead> <tbody> <tr> <td>VM2482A0</td> <td>ELECTR COMPONENT S HOLDER FRAME SHOP.PRO</td> <td>1.000</td> <td>PC</td> </tr> <tr> <td>VM2484A0</td> <td>ELECTRICAL CONNECTION CABLE CLAMP</td> <td>1.000</td> <td>PC</td> </tr> </tbody> </table> | Code | Description | Qty | UOM | VM2482A0 | ELECTR COMPONENT S HOLDER FRAME SHOP.PRO | 1.000 | PC | VM2484A0 | ELECTRICAL CONNECTION CABLE CLAMP | 1.000 | PC | | | | | | | | | | | | |
| Code | Description | Qty | UOM | | | | | | | | | | | | | | | | | | | | | | | | | | |
| VM2482A0 | ELECTR COMPONENT S HOLDER FRAME SHOP.PRO | 1.000 | PC | | | | | | | | | | | | | | | | | | | | | | | | | | |
| VM2484A0 | ELECTRICAL CONNECTION CABLE CLAMP | 1.000 | PC | | | | | | | | | | | | | | | | | | | | | | | | | | |

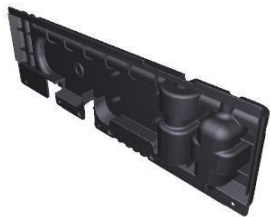

| COMPONENT | | | SPARE PART | | | | | | | | | | |
|-----------|--|---|------------|--|---|------|-------------|-----|-----|----------|--|-------|----|
| Code | Description | Image | Code | Description | Kit components | | | | | | | | |
| VM2483A | SHOP PRO COMPONENTS HOLDER COVER |  | KVM2483A | BL SHOP.PRO COMPONENTS HOLDER COVER KIT | <table border="1"> <thead> <tr> <th>Code</th> <th>Description</th> <th>Qty</th> <th>UOM</th> </tr> </thead> <tbody> <tr> <td>VM2483A1</td> <td>SHOP PRO COMPONENT S HOLDER COVER</td> <td>1.000</td> <td>PC</td> </tr> </tbody> </table> | Code | Description | Qty | UOM | VM2483A1 | SHOP PRO COMPONENT S HOLDER COVER | 1.000 | PC |
| Code | Description | Qty | UOM | | | | | | | | | | |
| VM2483A1 | SHOP PRO COMPONENT S HOLDER COVER | 1.000 | PC | | | | | | | | | | |
| VM2484A | ELECTRICAL CONNECTION CABLE CLAMP |  | KVM2484A | CABLE LOCKS ELECTRICAL CONNECTION KIT | <table border="1"> <thead> <tr> <th>Code</th> <th>Description</th> <th>Qty</th> <th>UOM</th> </tr> </thead> <tbody> <tr> <td>VM2484A0</td> <td>ELECTRICAL CONNECTION CABLE CLAMP</td> <td>1.000</td> <td>PC</td> </tr> </tbody> </table> | Code | Description | Qty | UOM | VM2484A0 | ELECTRICAL CONNECTION CABLE CLAMP | 1.000 | PC |
| Code | Description | Qty | UOM | | | | | | | | | | |
| VM2484A0 | ELECTRICAL CONNECTION CABLE CLAMP | 1.000 | PC | | | | | | | | | | |
| | | | KVM2482A | BAKERLUX SP ELECTR COMPONENTS HOLDER KIT | <table border="1"> <thead> <tr> <th>Code</th> <th>Description</th> <th>Qty</th> <th>UOM</th> </tr> </thead> <tbody> <tr> <td>VM2482A0</td> <td>ELECTR COMPONENT S HOLDER FRAME SHOP.PRO</td> <td>1.000</td> <td>PC</td> </tr> </tbody> </table> | Code | Description | Qty | UOM | VM2482A0 | ELECTR COMPONENT S HOLDER FRAME SHOP.PRO | 1.000 | PC |
| Code | Description | Qty | UOM | | | | | | | | | | |
| VM2482A0 | ELECTR COMPONENT S HOLDER FRAME SHOP.PRO | 1.000 | PC | | | | | | | | | | |
| | | | | | <table border="1"> <thead> <tr> <th>Code</th> <th>Description</th> <th>Qty</th> <th>UOM</th> </tr> </thead> <tbody> <tr> <td>VM2484A0</td> <td>ELECTRICAL CONNECTION CABLE CLAMP</td> <td>1.000</td> <td>PC</td> </tr> </tbody> </table> | Code | Description | Qty | UOM | VM2484A0 | ELECTRICAL CONNECTION CABLE CLAMP | 1.000 | PC |
| Code | Description | Qty | UOM | | | | | | | | | | |
| VM2484A0 | ELECTRICAL CONNECTION CABLE CLAMP | 1.000 | PC | | | | | | | | | | |